



MACHINE One by Maple



Endless Innovation

MAPLE TECHNOLOGY CO.,LTD.

No. 3-1, Zhongshan Rd., Shalu Dist.,
Taichung City 43348, Taiwan R.O.C.
Tel: +886-4-26150200 Fax: +886-4-26153906

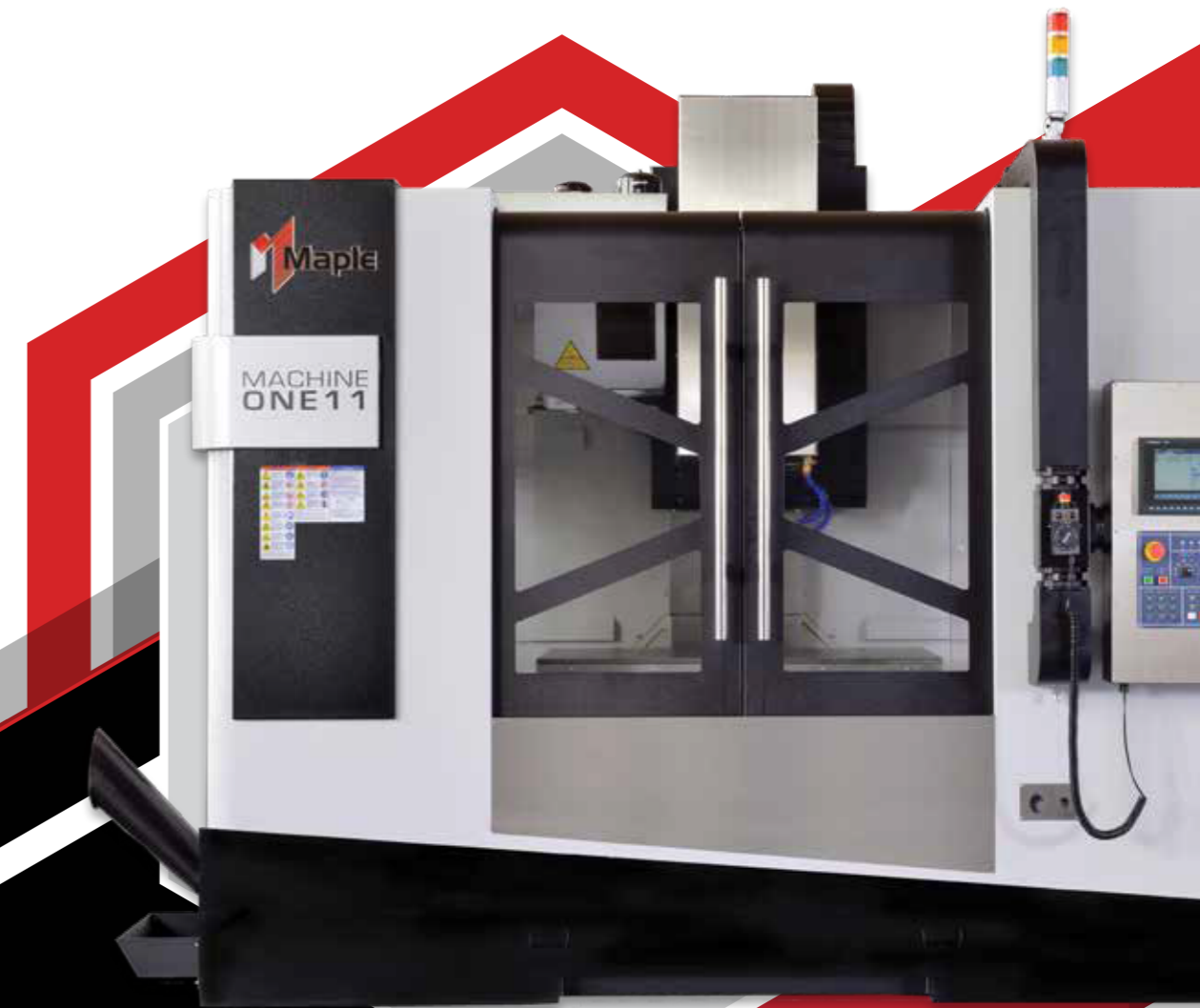

INTRODUCING
THE MAPLE M-ONE SERIES



www.maple-tech.com.tw



- Machine is designed with wide-stance casting.
- The main 5 large components of the machine consists of the stand, base, headstock, work table, and saddle are all create from high quality HT300 cast iron.
- Custom anti-flex chamber design helps both with reducing flex and vibration.



- Unlike many companies in the machine tool industry, we do not machine our castings when we receive them. We let the cast iron sit outside in rain or sun to let the casting take its natural flex change for 2-3 months.
- All work tables contact areas are heat treated to insure perfect hardness to reduce any damage that might occur during usage.

Motion Control



- M-One models uses high accuracy ballscrews constructed of high quality important materials that have been heat treated to prevent wear from usage. The ballscrews are created with an inner tubing design, this reduces noise associated with ballscrew travel by 20-40% compared to other standard ballscrews.

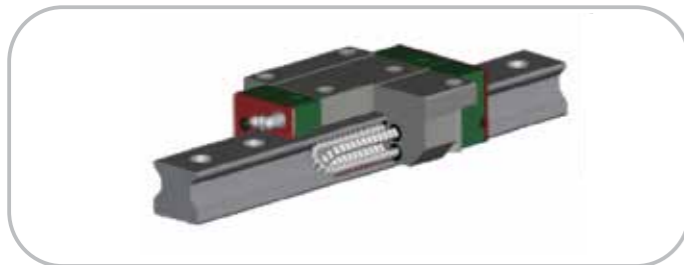

- All M-One series models uses roller type linear guide ways. High strength rollers have a great weight load capacity. Furthermore, the roller type guide ways are designed to have unbelievable tilt resistance. With P-grade roller type linear guide ways, perfect flatness is guarantee from every part machined.

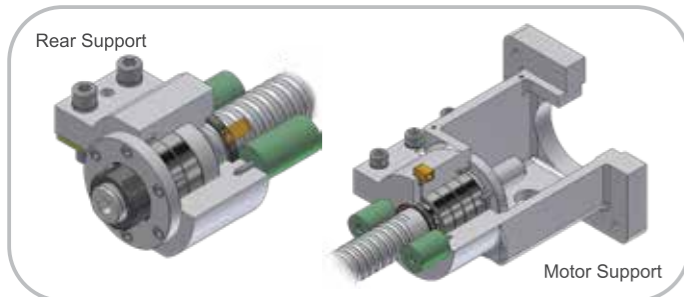

- Rigidity is the key to cutting faster, this is why we use four high accuracy heavy duty bearings in the motor mount and three high accuracy heavy duty bearings in the rear support. By doing so we increased the rigidity of the ballscrew support by 50% compare to standard machines in the industry.

Z-Axis Head Stock Strength



- The headstock being the part that takes the most stress, the headstock is equipped with roller type linear guide ways giving the headstock incredible strength in resisting flex and harmful vibration.
- With 6 heavy duty roller blocks installed on the Z-axis headstock, consistent contact is made between head stock and stand giving the M-One incomparable rigidity.
- Unbelievable structure design gives the headstock a reduced weight & enhanced strength. This gives the M-One the ability to move faster and at the same time consuming least power, interns make the machine more eco-friendly then most machines in the industry.

X-Axis Saddle Strength

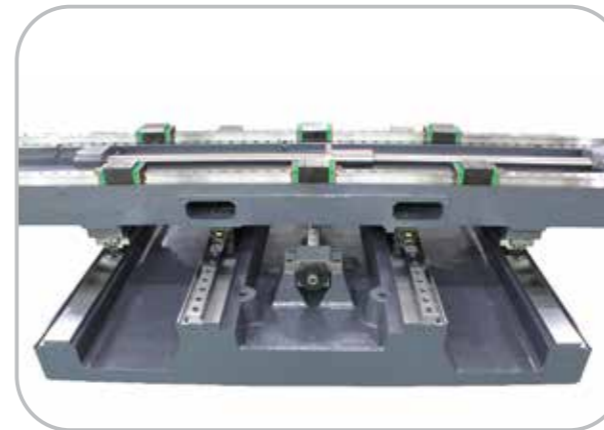

- The X-axis saddle is designed with 4 point support. This means that there is support at every 1/4 of the distance.
- With roller type guides, the saddle and work table can withstand forces from heavy cutting. The X axis saddle is supported with 6 heavy duty roller blocks that can withstand over 2 tons and is resistant to tilt due to an unbalanced work piece.
- Heavy tension roller type guide ways were selected to reduce vibration to work piece giving higher precision cuts and finer finishes.

Y-Axis Saddle Strength

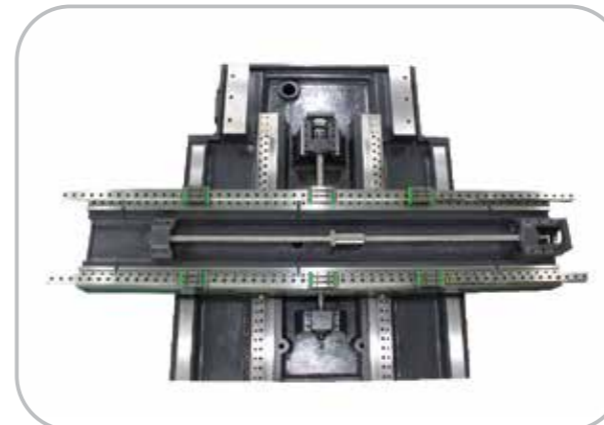

- With a base support wide as the saddle. The base gives complete and total balance to the whole machine without any problem.
- Incredible 4 roller blocks and 4 roller supports. Regardless of where the work piece lays. The work piece will still be balance to perfection.

Analysis Features

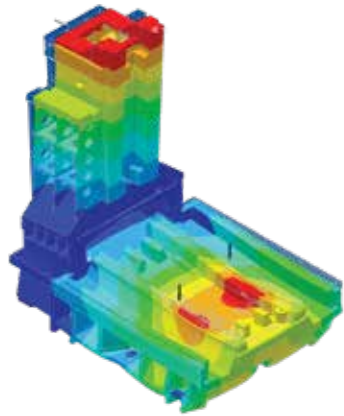

■ Knowing Your Creation

All M-One series machines are designed and analyzed by high tech computer software. By doing so we are able to test the rigidity under heavy machining stress and machine flex. We are one of the few manufacture by going the extra mile were able to create a machine that is balanced in weight and strength in every aspect of the machine.

Machine Shipping Features

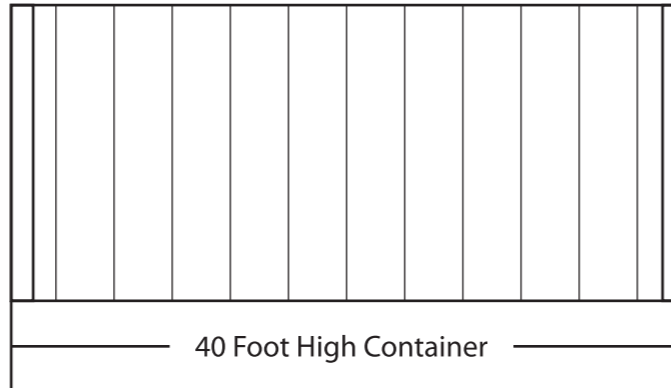

■ 40 Foot Container Fitment

M-One6	4 Units	M-One20	2 Units
M-One8	3 Units	M-One40	2 Units
M-One10	3 Units	M-One60	2 Units
M-One11	3 Units	M-One80	2 Units

■ Non-Dismantelment

The M-One model machining center features one and only non dismantelment shipping. This meanings that the machine can fit in to containers without being taken apart and have to be put together again; this wasts time and money.

2-Step Gear Box Features



■ 2-Step Gear Box explanation

A spur gear is adopted in the transmission of the spindle in order to increase the efficiency of transmission and to strengthen the rigidity of cutting.

With two step gears installed in head stock. We are able to switch between hi and low gear giving the spindle two different charecters. With hi speed we get the speed like most standard spindle. With low-speed we get 3 times the milling power compared to standard spindles.

Our 2-step gear box spindle has less backlash compared to the ZF type gear boxes. Without a belt to transmit the movement from spindle motor to gear, we are able to solve the problem of backlash from the belt with direct gear to gear tranmission.

Furthermore, reliability of the gear transmission designed used within the M-One 2 step gear box increase the life of both the spindle and the gears. By having sensors installed in 3 staged areas. The gears and spindle are both protected from unexpect-ed crashes.

The cooling-compelled recurring devices are equipp-ed in to the main bearing box, transmitted gear, and gear transmission bearing. Hence, the thermal heat is reduced and the accuracy of the spindle is prolonged.



Spindle Features

■ Built in (High Speed Equipment)

The M-One built in spindle is the most advanced spindle feature in the M-One series spindle line up. With speeds ranging from 15,000-30,000 rpm providing mirror finishing results to many applications.

■ Belt Driven (Standard Equipment)

Standard configuration for the M-one series is a belt driven spindle. The belt driven spindle is the most economic and most frequently used spindle in the world. M-One series can equipement belt type spindle from 40 to 50 taper, with speeds at 6000-12000 rpm.

■ In-Line (Mid Range Equipment)

The in-line M-One spindle design is an innovative 12,000 to 15,000-rpm, inline, direct-drive spindle that is coupled directly to the motor. This provides super-smooth operation for excellent surface finishes, and reduces operating heat for greater thermal stability.

■ BT40 & BT50 2-Step Gear Box (Heavy Duty Equipment)

The M-One geared-head spindle provides increased low-end torque for heavy cutting, while retaining the ability to run up to 6,000, 10,000, 12,000 rpm for high-speed machining. It can be equipped with 40 or 50 taper spindles, providing 3x the standard N.m. of torque compared to standard spindles.

Control board Tech Features



■ 4 way swival control panel

The M-One model machining center futures one andonly 4 way swival control panel. By being able to swival multiple axis, the user can adjust the monitor to the perfect viewing position that the operator desires.

The 4 way swival controller panel is not limited in anyway. This means the swival controller can be equipped with controllers ranging for Fanuc, Mitsubishi, Siemens, and Heindenhein.

Specification		M-One 6	M-One 8s	M-One 8	M-One 10s	M-One 10	M-One 11	M-One 20	M-One 40	M-One 60
Travel										
X-Axis Travel	MM	650	850	850	1000	1020	1100	1200	1400	1600
Y-Axis Travel	MM	550	550	600	550	600	600	600	650	700
Z-Axis Travel	MM	550	550	600	550	600	600	600	620	620
Spindle Nose To Worktable Surface	MM	110-610	150-750	150-750	150-700	150-750	150-750	150-750	110-730	110-730
Worktable										
Table Size	MM	800 x 550	1000 x 550	950 x 600	1100 x 550	1100 x 600	1200 x 600	1300 x 600	1500 x 700	1700 x 700
Working Area	MM	650 x 550	850 x 550	850 x 600	1000 x 550	1020 x 600	1100 x 600	1200 x 600	1400 x 650	1600 x 700
T-Slot	MM	18 x 5 x 80	18 x 5 x 80	18 x 5 x 100	18 x 5 x 100	18 x 5 x 100	18 x 5 x 100	18 x 5 x 100	19 x 5 x 120	20 x 5 x 120
Work Table Max Weight	Kgs	700	800	800	800	1000	1000	1200	1500	1700
Spindle										
Spindle Taper		BT40	BT40	BT40	BT40	BT40	BT40	BT40	BT50	BT50
Spindle Speed (St. Belt)	RPM	10,000	10,000	10,000	10,000	10,000	10,000	10,000	6,000	6000
Spindle Speed (Op. Direct)	RPM	12,000	12,000	12,000	12,000	12,000	12,000	12,000	12,000	12,000
Spindle Motor-Fanuc	KW	11	11	15	11	15	15	15	18.5	18.5
Spindle Motor-Mitsubishi	KW	7.5	7.5	11	7.5	11	11	11	15	15
Spindle Motor-Siemens	KW	7	7	9	7	9	9	9	15	15
Three-Axis Motor										
X/Y/Z-Axis Servo Motor-Fanuc	KW	1.8/1.8/3.0	1.8/1.8/3.0	1.8/1.8/3.0	1.8/1.8/3.0	3.0/3.0/3.0	3.0/3.0/3.0	3.0/3.0/3.0	3.0/3.0/3.0	3.0/3.0/3.0
X/Y/Z-Axis Servo Motor-Mitsubishi	KW	1.5/1.5/3.0	1.5/1.5/3.0	1.5/1.5/3.0	1.5/1.5/3.0	3.0/3.0/3.0	3.0/3.0/3.0	3.0/3.0/3.0	3.0/3.0/4.5	3.0/3.0/4.5
X/Y/Z-Axis Servo Motor-Siemens	KW	2.3/2.3/3.3	2.3/2.3/3.3	3.25/3.25/3.25	2.3/2.3/3.3	3.25/3.25/3.25	3.25/3.25/3.25	3.25/3.25/3.25	3.25/3.25/5.65	3.25/3.25/5.65
3-Axis Cutting Feedrate	M M/Min	12000	12000	12000	12000	12000	12000	12000	12000	10000
3-Axis Rapid Traverse	M/Min	36/36/36	36/36/36	36/36/36	36/36/36	36/36/36	36/36/36	36/36/36	24/24/24 (36)	24/24/24(36)
Accuracy										
Positioning-(JIS 6338) (±)	MM	0.005	0.005	0.005	0.005	0.005	0.005	0.005	0.005	0.005
Repeatability-(JIS6338) (±)	MM	0.003	0.003	0.003	0.003	0.003	0.003	0.003	0.003	0.003
Tool Changer										
Tool Changer Type		Arm Type	Arm Type	Arm Type	Arm Type	Arm Type	Arm Type	Arm Type	Arm Type	Arm Type
Tool Loading Capacity		24 Tools	24 Tools	24 Tools	24 Tools	24 Tools	24 Tools	24 Tools	24 Tools	24 Tools
Tool Selection Method	ΦMM	Bi-Directional, Random	Bi-Directional, Random	Bi-Directional, Random	Bi-Directional, Random	Bi-Directional, Random	Bi-Directional, Random	Bi-Directional, Random	Bi-Directional, Random	Bi-Directional, Random
Max.Tool Dia./Length	ΦMM	Φ80 / 300	Φ80 / 300	Φ80 / 300	Φ80 / 300	Φ80 / 300	Φ80 / 300	Φ80 / 300	Φ110(127) / 300	Φ110(127) / 300
Max.Tool Weight	MM	7	7	7	7	7	7	7	15	15
Tool Shank Spec.	Kgs	BT40/CAT40	BT40/CAT40	BT40/CAT40	BT40/CAT40	BT40/CAT40	BT40/CAT40	BT40/CAT40	BT50/CAT50	BT50/CAT50
Tool Changer Time		T-T:2.3 Sec ; C-C: 4.5 Sec	T-T:2.3 Sec ; C-C: 4.5 Sec	T-T:2.3 Sec ; C-C: 4.5 Sec	T-T:2.3 Sec ; C-C: 4.5 Sec	T-T:2.3 Sec ; C-C: 4.5 Sec	T-T:2.3 Sec ; C-C: 4.5 Sec	T-T:2.3 Sec ; C-C: 4.5 Sec	T-T:3.5 Sec ; C-C: 7 Sec	T-T:3.5 Sec ; C-C: 7 Sec
Others										
Machine Dimensions	(L x W x H)	2.27 x 2.5 x 2.3	2.27 x 2.5 x 2.3	2.27 x 2.5 x 2.3	2.27 x 2.5 x 2.3	2.27 x 2.9 x 2.4	2.27 x 2.9 x 2.4	2.27 x 3.1 x 2.4	3.9 x 2.58 x 3.1	3.9 x 2.58 x 3.1
Machine Weight / Gross Weight	Kgs	4400	4500	6000	4600	6200	6300	6500	9000	9800

Standard Accessories:

- Arm Type Automatic Tool Changer (24 Tools)
- Fully Enclosed Guard
- Swiveling Control Box
- Swiveling Control Box
- LED 3 Color Warning Light
- Volumetric Type Automatic Lubricator
- Coolant and Chip Flushing System
- Screw type chip conveyor with cart
- Auto Power Off
- Rigid Tapping
- Tool Box
- Leveling Screws & Blocks
- Operation Manual
- Mechanical Oil Coolant Separator
- Air Gun

Optional Accessories:

- Coolant Gun
- Coolant Through Tool Holder
- Coolant Through Spindle (CTS)
- Transformer
- Chip Conveyor
- Spindle Upgrade 12k rpm (Belt Type)
- Spindle Upgrade 18/20/24k rpm (Built-in)
- Spindle Upgrade 12/14/18K rpm (Direct Drive)
- Linear Scale
- CNC Rotary Table
- Automatic Tool Probe
- Automatic Tool Setter
- Maple In-Line Gear Box
- ZF Gearbox
- Spin Window

M-One series
Machine Measurements

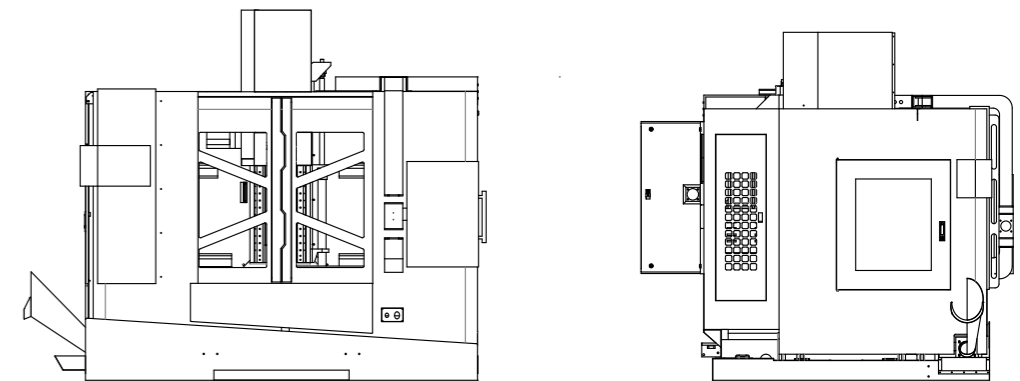

M-One Series	M-One 6	M-One 8	M-One 10	M-One 11	M-One 20	M-One 40	M-One 60
Depth(mm)	2020mm	2020mm	2230mm	2230mm	2576 mm	2576 mm	2576 mm
Width(mm)	2270mm	2270mm	2660mm	2660mm	3895 mm	3895 mm	3895 mm
Height(mm)	2640mm	2740mm	2740mm	2740mm	3086 mm	3086 mm	3086 mm