

精密組鑽石銼刀 / Diamond Needle Files

PF-10

- Total length : 140mm
- Tool shank : \varnothing 3.0mm
- Diamond coating length : 50mm



全長：140mm，柄徑： \varnothing 3.0mm，鑽石長：50mm

形狀與尺寸 Shape & Size (mm)	編號 / Order no.		
	#120	#200	#400
1. 5.5 X 1.5	PF-101	PF-101F	PF-101V
2. 5 X 2	PF-102	PF-102F	PF-102V
3. \varnothing 3	PF-103	PF-103F	PF-103V
4. 2.5	PF-104	PF-104F	PF-104V
5. 3.5	PF-105	PF-105F	PF-105V
套裝5支組 / 5 pcs. set	PF-100	PF-100F	PF-100V

PF-10L

- Total length : 140mm
- Tool shank : \varnothing 3.0mm
- Diamond coating length : 70mm



全長：140mm，柄徑： \varnothing 3.0mm，鑽石長：70mm

形狀與尺寸 Shape & Size (mm)	編號 / Order no.		
	#120	#200	#400
1. 5.5 X 1.5	PF-101L	PF-101LF	PF-101LV
2. 5 X 2	PF-102L	PF-102LF	PF-102LV
3. \varnothing 3	PF-103L	PF-103LF	PF-103LV
4. 2.5	PF-104L	PF-104LF	PF-104LV
5. 3.5	PF-105L	PF-105LF	PF-105LV
6. 5.4 X 1.5	PF-106L	PF-106LF	PF-106LV
7. 1.7 X 6	PF-107L	PF-107LF	PF-107LV
8. 6 X 2	PF-108L	PF-108LF	PF-108LV
9. 5 X 2	PF-109L	PF-109LF	PF-109LV
10. 6 X 1.5	PF-110L	PF-110LF	PF-110LV
套裝10支組 / 10 pcs. set	PF-100L	PF-100LF	PF-100LV

PF-70 Thin flat type

This thin flat type files with 0.5 ~ 1.0mm thickness, it is suitable for filing some narrow gap.

- Total length: 140mm, Tool shank : \varnothing 3.0mm
- Diamond coating length : 40 ~ 50mm



PF-70 超薄平銼

此系列薄銼適用於窄縫加工。

全長：140mm，柄徑： \varnothing 3.0mm，鑽石長：40 ~ 50mm

形狀與尺寸 Shape & Size (mm)	編號 / Order no.		
	#150	#200	#400
1. 5.5 X 0.5	PF-705	PF-705F	PF-705V
2. 5.5 X 0.8	PF-708	PF-708F	PF-708V
3. 5.5 X 1.0	PF-710	PF-710F	PF-710V

精密組鑽石銼刀 / Diamond Needle Files

PFL-10

- Total length : 180mm
- Tool shank : ϕ 3.0mm cover with PVC vinyl
- Diamond coating length : 25 ~ 50mm



全長 : 180mm 柄徑 : ϕ 3.0mm 套膠柄 鑽石長 : 25 ~ 50mm

形狀與尺寸 Shape & Size (mm)	編號 / Order no.		
	#200	#150	#400
1.  5.5 X 1.5	PFL-101	PFL-101J	PFL-101V
2.  5 X 2	PFL-102	PFL-102J	PFL-102V
3.  ϕ 3	PFL-103	PFL-103J	PFL-103V
4.  2.5	PFL-104	PFL-104J	PFL-104V
5.  3.5	PFL-105	PFL-105J	PFL-105V
6.  5.5 X 1	PFL-106	PFL-106J	PFL-106V
7.  5.5 X 0.5	PFL-705	PFL-705J	PFL-705V
8.  5.5 X 0.8	PFL-708	PFL-708J	PFL-708V
9.  ϕ 2	PFL-03	PFL-03J	PFL-03V
10.  5.5 X 1.5	PFL-01	PFL-01J	PFL-01V
套裝10支組 / 10 pcs. set	PFL-100	PFL-100J	PFL-100V

PF-20

- Total length : 200mm
- Tool shank : ϕ 4.0mm
- Diamond coating length : 70mm



全長 : 200mm 柄徑 : ϕ 4.0mm 鑽石長 : 70mm



形狀與尺寸 Shape & Size (mm)	編號 / Order no.		
	#120	#200	#400
1.  8.5 X 1.6	PF-201	PF-201F	PF-201V
2.  7 X 2.5	PF-202	PF-202F	PF-202V
3.  ϕ 4	PF-203	PF-203F	PF-203V
4.  3.5	PF-204	PF-204F	PF-204V
5.  4.5	PF-205	PF-205F	PF-205V
套裝5支組 / 5 pcs. set	PF-200	PF-200F	PF-200V

PF-30

- Total length: 180mm
- Tool shank : ϕ 3.4mm
- Diamond coating length : 60mm



全長 : 180mm 柄徑 : ϕ 3.4mm 鑽石長 : 60mm

形狀與尺寸 Shape & Size (mm)	編號 / Order no.		
	#120	#200	#400
1.  7.5 X 1.5	PF-301	PF-301F	PF-301V
2.  6 X 2.1	PF-302	PF-302F	PF-302V
3.  ϕ 3.5	PF-303	PF-303F	PF-303V
4.  3	PF-304	PF-304F	PF-304V
5.  4	PF-305	PF-305F	PF-305V
套裝5支組 / 5 pcs. set	PF-300	PF-300F	PF-300V

鑽石異形銼刀 / Diamond Bent Files

BF-60

- Total length : 140mm
- Tool shank : $\varnothing 3.0\text{mm}$
- Diamond coating length : 30mm



全長 : 140mm 柄徑 : $\varnothing 3.0\text{mm}$ 鑽石長 : 30mm

形狀與尺寸 Shape & Size (mm)	編號 / Order no.		
	#150	#200	#400
1. 5.5 X 1.2	BF-601	BF-601F	BF-601V
2. 5 X 2	BF-602	BF-602F	BF-602V
3. $\varnothing 3$	BF-603	BF-603F	BF-603V
4. 2.5	BF-604	BF-604F	BF-604V
5. 3.5	BF-605	BF-605F	BF-605V
套裝5支組 / 5 pcs. set	BF-600	BF-600F	BF-600V

BF-80

- Total length : 155mm
- Tool shank : 3.0mm square shank
- Diamond coating length : 20 ~ 30mm (Double head)



全長 : 155mm 柄徑 : 3.0mm方柄 鑽石長 : 20 ~ 30mm (雙頭)

形狀與尺寸 Shape & Size (mm)	編號 / Order no.		
	#200	#150	#400
1. 3 X 2	BF-801	BF-801J	BF-801V
2. $\varnothing 2$	BF-802	BF-802J	BF-802V
3. $\varnothing 3$	BF-803	BF-803J	BF-803V
4. $\varnothing 3$	BF-804	BF-804J	BF-804V
5. 3	BF-805	BF-805J	BF-805V
6. 3	BF-806	BF-806J	BF-806V
套裝6支組 / 6 pcs. set	BF-800	BF-800J	BF-800V

BF-90

- Total length : 140mm
- Tool shank : $\varnothing 3.0\text{mm}$
- Diamond coating length : 20mm



全長 : 140mm 柄徑 : $\varnothing 3.0\text{mm}$ 鑽石長 : 20mm

形狀與尺寸 Shape & Size (mm)	編號 / Order no.		
	#150	#200	#400
1. 6 X 1.3	BF-901	BF-901F	BF-901V
2. 2.5	BF-902	BF-902F	BF-902V
3. 3.5 X 1.5	BF-903	BF-903F	BF-903V
4. 3.5	BF-904	BF-904F	BF-904V
5. 5 X 2	BF-905	BF-905F	BF-905V
6. 3.5 X 1.5	BF-906	BF-906F	BF-906V
7. 3.5 X 2	BF-907	BF-907F	BF-907V
8. $\varnothing 3$	BF-908	BF-908F	BF-908V
9. 5 X 1.5	BF-909	BF-909F	BF-909V
10. $\varnothing 2.3$	BF-910	BF-910F	BF-910V
套裝10支組 / 10 pcs. set	BF-900	BF-900F	BF-900V

鑽石平斜銼刀 / Diamond Tapered Hand Files



PTF-100



CF-400

PTF-100

單位 / Unit : mm

	全長 Total length	鑽石長 Dia. length	形狀 Cross-section	粒度 Grit size	編號 Order no.
	130	30		#200	PTF-12F
				#400	PTF-12V
				#600	PTF-12X
	130	30		#200	PTF-14F
				#400	PTF-14V
				#600	PTF-14X
	130	30		#200	PTF-16F
				#400	PTF-16V
				#600	PTF-16X
	140	50		#600	PF-103X

10支套裝 / 10 pcs. set in pvc pouch, contains one each of all above files

PTF-100

CF-400

單位 / Unit : mm

	全長 Total length	鑽石長 Dia. length	形狀 Cross-section	粒度 Grit size	編號 Order no.
	180	40		#150	CF-402J
				#200	CF-402F
				#400	CF-402V
	180	50		#150	CF-404J
				#200	CF-404F
				#400	CF-404V
	180	50		#150	CF-406J
				#200	CF-406F
				#400	CF-406V
	180	50		#150	CF-408J
				#200	CF-408F
				#400	CF-408V







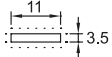

12支套裝 / 12 pcs. set in pvc pouch, contains one each of all above files

CF-400

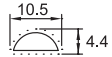
鐵工用鑽石銼刀 / Diamond Hand Files







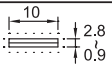

IF-50 鐵工用鑽石銼刀 / Diamond Hand Files

單位 / Unit : mm

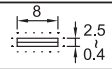
粒度/Grit size : #100	全長 Total length	鑽石長 Dia. length	形狀 Cross-section	編號 Order no.
	215	80		IF-501
	215	80		IF-502
	215	80		IF-503
	215	80		IF-504
	215	80		IF-505

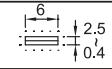
CF-50 鑽石平斜銼刀 / Diamond Hand Tapered Files

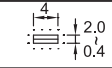
單位 / Unit : mm

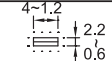



粒度/Grit size : #150, #200	全長 Total length	鑽石長 Dia. length	形狀 Cross-section	編號 Order no.
	180	70		CF-501
	180	60		CF-502
	180	60		CF-503
	180	50		CF-504
	180	50		CF-505

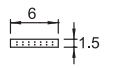

CF-500 木盒裝5支組 / (5pcs. set / wooden case)

金屬結合鑽石銼刀 / Sintered Diamond Files

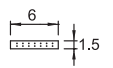
單位 / Unit : mm

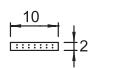
	全長 Total length	鑽石長 Dia. length	形狀 Cross-section	粒度 Grit size	編號 Order no.
	54	20		#200	MMF-615F
				#400	MMF-615V
				#600	MMF-615X
	72	20		#200	MDT-02F
				#400	MDT-02V
				#600	MDT-02X
	105	20		#200	MDT-03F
				#400	MDT-03V
				#600	MDT-03X

電動及氣動超音波研磨機專用 / Special design for pneumatic or ultrasonic lapping machine.

鑽石銼刀片 / Diamond Tip Files

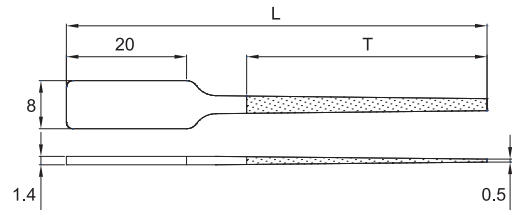

單位 / Unit : mm

L	T	形狀 Shape	粒度 Grit size	編號 Order no.
70	40		#150	FA-632J
			★#200	★FA-632F
			★#400	★FA-632V
			★#600	★FA-632X
80	50		★#150	★FA-643J
			★#200	★FA-643F
			★#400	★FA-643V
			★#600	FA-643X
90	50		★#150	★FA-666J
			★#200	★FA-666F
			★#400	FA-666V
			★#600	FA-666X
90	50		★#150	★FA-688J
			★#200	★FA-688F
			★#400	FA-688V
			★#600	FA-688X
		(122)		XH-32

FAS-600

10支綜合組裝包含上表有 ★ 標示之銼刀各一支。(銼刀夾柄另購)

10pcs. assortment set / pvc pouch, containing one each of file which denoted by asterisk. (Tool holder is optional.)

特點：

1. 節省材料。
2. 配合夾柄 (XH-32) 使用，手感更好。
3. 全新製程，切削力及壽命更好。
4. 可手持操作，亦可夾於機器上使用。
5. 銼刀形狀設計更合乎人體工學。
6. 可取代一般鑽石平斜銼刀。



Features :

1. Less material usage.
2. The usage of holder (XH-32) makes it feel much better when operating.
3. Brand-new manufacturing process provides a better cutting ability and also prolongs the tool life.
4. Both suitable for hand-held and machine-mounted operations.
5. The designation is complied with the ergonomic.
6. Be able to replace the general diamond tapered hand files.

鑽石銼刀片 / Diamond Tip Files

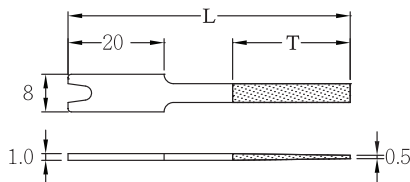

單位 / Unit : mm

L	T	形狀 Cross-section	粒度 Grit size	編號 Order no.
60	25		#150	★FA-426J
			#200	★FA-426F
			#400	FA-426V
60	25		#150	★FA-446J
			#200	★FA-446F
			#400	FA-446V
70	40		#150	★FA-667J
			#200	★FA-667F
			#400	FA-667V
70	40		#150	FA-887J
			#200	FA-887F
			#400	FA-887V
90	60		#150	★FA-889J
			#200	★FA-889F
			#400	FA-889V
70	40		#150	FA-107J
			#200	FA-107F
			#400	FA-107V
90	60		#150	★FA-109J
			#200	★FA-109F
			#400	FA-109V
60	25		#200	FA-326F
			#400	FA-326V
			#600	FA-326X
60	25		#200	FA-436F
			#400	FA-436V
			#600	FA-436X
70	40		#200	FA-327F
			#400	FA-327V
			#600	FA-327X
70	40		#200	FA-437F
			#400	FA-437V
			#600	FA-437X
(122)				XH-12



10支組木盒裝，含夾柄1支及有★標示之銼刀各1支。
 10pcs. Set with tool holder / wooden case, containing one each of file which denoted by asterisk and one tool holder (XH-12). **FAS-100T**

特點：

- (1) 富彈性，可彎曲研磨。
- (2) 厚度只有1mm，適合夾縫研磨。
- (3) 適合用於各種銼磨機及手持加工。

Features：

- (1) With the maximum thickness of 1mm only, the files are suitable for narrow and deep gap processing. Contoured to make difficult-to-reach areas readily accessible.
- (2) They are tapered in thickness to make possible perfectly flat filing and flexible for bending while still maintaining their hardness.
- (3) Both suitable for hand-held and machine-mounted operations.

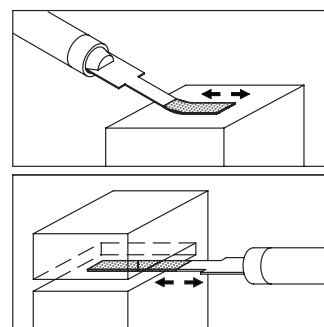

鑽石機械平斜銼刀 / Diamond Tapered Machine Files







MTP-120

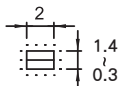

MTF-100

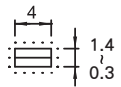

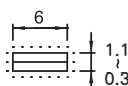



MTP Series

單位 / Unit : mm				
全長 Total length	鑽石長 Dia. length	形狀 Cross-section	粒度 Grit size	編號 Order no.
	72		#150	MTP-12J
			#200	MTP-12F
			#300	MTP-12H
			#400	MTP-12V
	72		#150	MTP-14J
			#200	MTP-14F
			#300	MTP-14H
			#400	MTP-14V
	72		#150	MTP-16J
			#200	MTP-16F
			#300	MTP-16H
			#400	MTP-16V

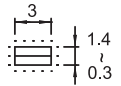
12支套裝 / 12 pcs. set in pvc pouch

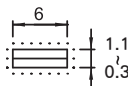
MTP-120

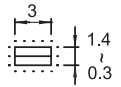
MTF Series

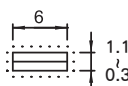
單位 / Unit : mm				
全長 Total length	鑽石長 Dia. length	形狀 Cross-section	粒度 Grit size	編號 Order no.
	72		#200	MTF-13F
			#400	MTF-13V
			#600	MTF-13X
	72		#200	MTF-16F
			#400	MTF-16V
			#600	MTF-16X
	56		#200	MTF-23F
			#400	MTF-23V
			#600	MTF-23X
	56		#200	MTF-26F
			#400	MTF-26V
			#600	MTF-26X

12支套裝 / 12 pcs. set in pvc pouch

MTF-100

鑽石機械銼刀 / Diamond Machine Files

MPF-10

- Total length : 90mm
- Tool shank : $\varnothing 3.0\text{mm}$
- Diamond coating length : 45mm



全長 : 90mm 柄徑 : $\varnothing 3.0\text{mm}$ 鑽石長: 45mm

形狀與尺寸 Shape & Size (mm)	編號 / Order no.		
	#150	#200	#400
1.  4 X 1.2	MPF-101	MPF-101F	MPF-101V
2.  5 X 2	MPF-102	MPF-102F	MPF-102V
3.  $\varnothing 3$	MFF-103	MPF-103F	MPF-103V
4.  2.5	MPF-104	MPF-104F	MPF-104V
5.  5 X 2	MPF-109	MPF-109F	MPF-109V
套裝5支組 / 5 pcs. set	MPF-100	MPF-100F	MPF-100V

MBF-60

- Total length : 85mm
- Tool shank : $\varnothing 3.0\text{mm}$
- Diamond coating length : 30mm



全長 : 85mm 柄徑 : $\varnothing 3.0\text{mm}$ 鑽石長: 30mm



形狀與尺寸 Shape & Size (mm)	編號 / Order no.		
	#150	#200	#400
1.  5.5 X 1.2	MBF-601	MBF-601F	MBF-601V
2.  5 X 2	MBF-602	MBF-602F	MBF-602V
3.  $\varnothing 3$	MBF-603	MBF-603F	MBF-603V
4.  2.5	MBF-604	MBF-604F	MBF-604V
5.  3.5	MBF-605	MBF-605F	MBF-605V
套裝5支組 / 5 pcs. set	MBF-600	MBF-600F	MBF-600V

MBF-90

- Total length : 65mm
- Tool shank : $\varnothing 3.0\text{mm}$
- Diamond coating length : 20 ~ 30mm



全長 : 65mm 柄徑 : $\varnothing 3.0\text{mm}$ 鑽石長 : 20 ~ 30mm

形狀與尺寸 Shape & Size (mm)	編號 / Order no.		
	#150	#200	#400
1.  5.8 X 1.2	MBF-901	MBF-901F	MBF-901V
2.  3.2 X 1.4	MBF-902	MBF-902F	MBF-902V
3.  5 X 2	MBF-903	MBF-903F	MBF-903V
4.  3.2 X 1.4	MBF-904	MBF-904F	MBF-904V
5.  $\varnothing 3$	MBF-905	MBF-905F	MBF-905V
6.  $\varnothing 3$	MBF-906	MBF-906F	MBF-906V
7.  2.5	MBF-907	MBF-907F	MBF-907V
8.  3.2 X 1.4	MBF-908	MBF-908F	MBF-908V
9.  3.2 X 1.4	MBF-909	MBF-909F	MBF-909V
10.  3.5 X 2	MBF-910	MBF-910F	MBF-910V
套裝10支組 / 10 pcs. set	MBF-900	MBF-900F	MBF-900V