

WIN CHANCE

INNOVATIVE
ERGONOMIC DESIGN
GREEN CONCEPT

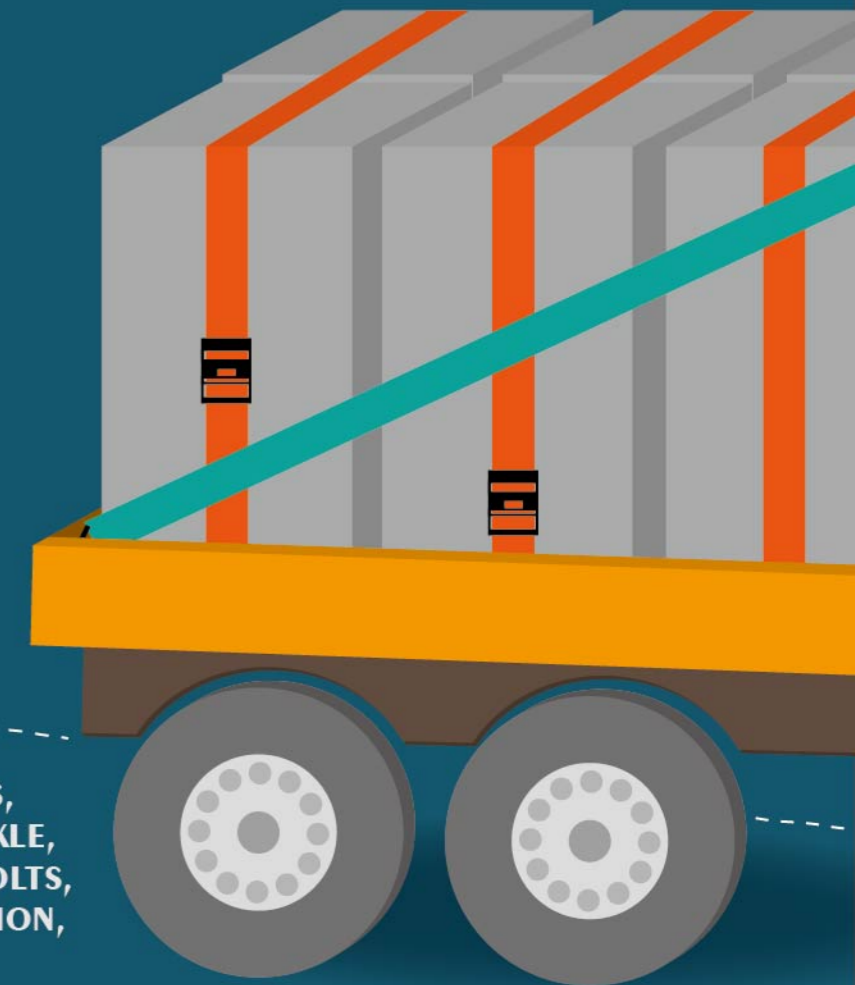

WIN CHANCE
HIGH QUALITY HARDWARE
MANUFACTURER

METAL HARDWARE & COMPONENTS,
CAR ACCESSORIES, RATCHET BUCKLE,
TIE DOWN, STRAPS, FASTENERS, BOLTS,
HOOKS, SHACKLES, FALL PROTECTION,
CARABINER, ETC...



WIN CHANCE METAL CO., LTD

鈞成金屬股份有限公司

No.15-10, Lane 142, Sec. 5 Chang Nan Rd.,
Changhua City 50088 Taiwan

T: +886-4-7382460 F: +886-4-7388180

<http://www.winchance.tw>
<http://www.hooksnet.com.tw>





ABOUT US

Win Chance Metal Co., Ltd. is a professional manufacturer of metal hardware, forging parts, wire-forming part, stamped & pressed parts and all kinds of ratchet buckles. We earned an excellent reputation through more than 20 years of business experience.

In summary a combination of experience and young enthusiastic staff ensure that we stay ahead of the competition in all that we strive to achieve and remain the best quality for our long term goals.



Content

RATCHET BUCKLE

A.B.S Series	04
Extendable Series	05
Detachable Series	06
Retractable Series	07
Stainless Series	08
Aluminum Series	09
Ergonomic Rubber Grip Series	10
Conjoined Hook Series	11
Traditional Series	12
Multi-function Super RatchetBuckle	14
Ratchet Load Binder	14
Roller Chain Binder	15
Chain Binder	15

RATCHET TIE DOWN

16

LEVER BLOCK

18

CAM BUCKLE

19

STAMPING PARTS

20

WIRE FORMING PARTS

Ring	22
Buckle	23
Hook	24
J Hook	26
S Hook	28
Bolt	29

FITTING

30

FORGING PARTS

31

FALL PROTECTION

32

Steel Carabiner	34
Aluminum Carabiner	37
Fall Protection For Tools	39
Snap Hook	39
Safety Buckle	41
Swivel Connector	41



PRECISION PUNCHING MACHINE

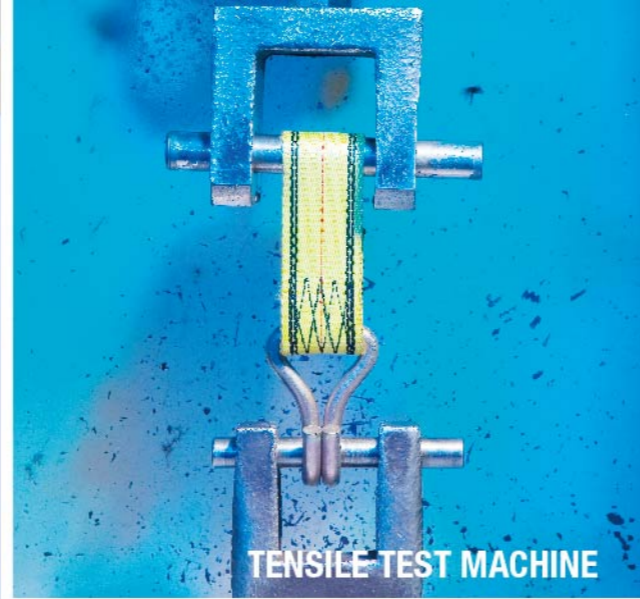

TENSILE TEST MACHINE



SAND BLASTING MACHINE



SALT SPRAY TEST MACHINE

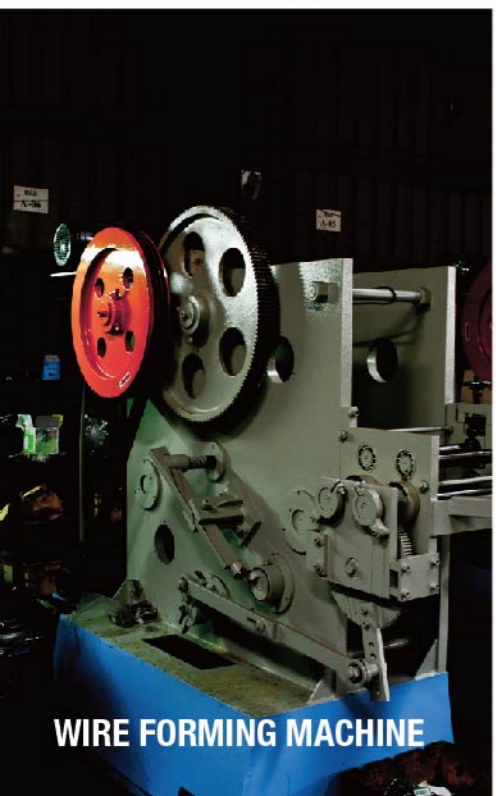

WIRE FORMING MACHINE



AUTOMATIC SPRING MACHINE



PRECISION PUNCHING MACHINE

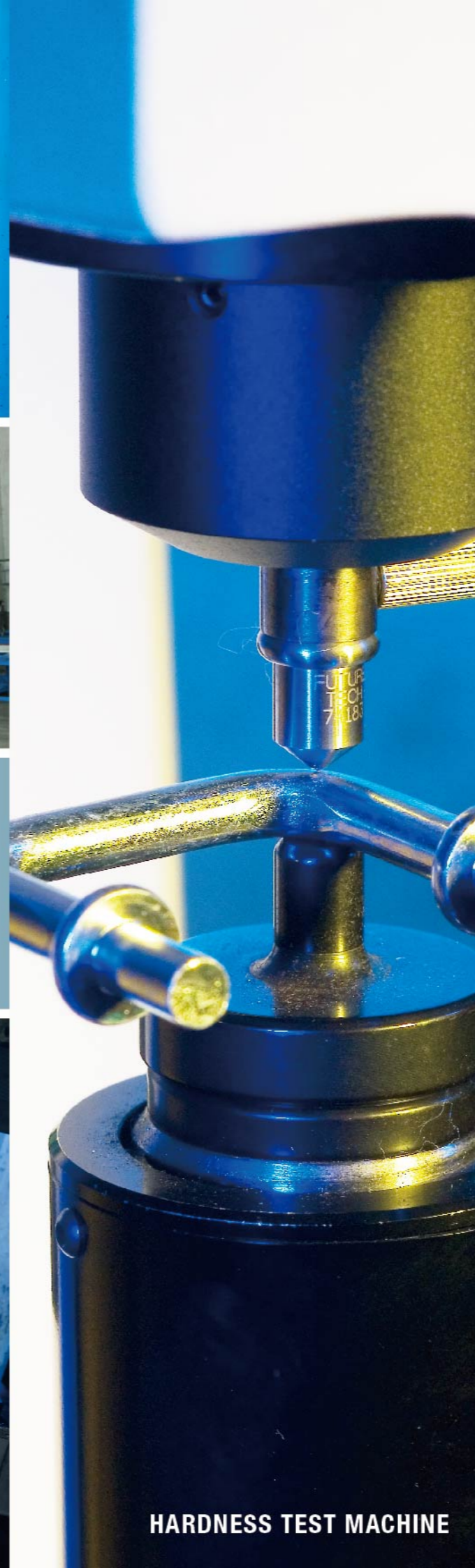

HARDNESS TEST MACHINE

RATCHET BUCKLE

A.B.S Series

Ideal for commercial use.
Heavy duty load securing preferred.
Built-in safety device for slow down the release during off-load.
Ergonomic wide plastic grip for ease operation.

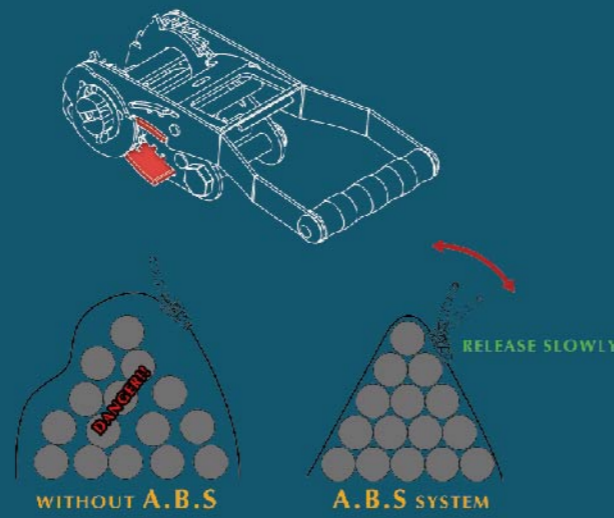

RATCHET BUCKLE

Extendable Series

Made for diagonal lashing.
Powerful working ability.
Telescopic handle for better pre-tension.

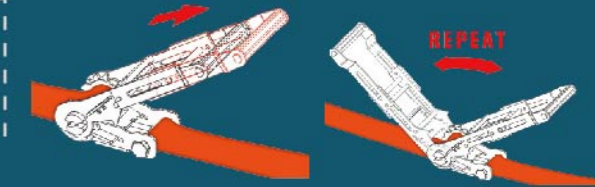

MORE LEVERAGE



**2" A.B.S Ratchet Buckle
RB51R-001**

Size: 2"/50mm
B.S: 5000kg
Finish: Zinc & Electric Black
Long lever type
Ergonomic wide plastic grip



**2" Extendable A.B.S Ratchet Buckle
RB51ER-001**

Size: 2"/50mm
B.S: 5000kg
Finish: Zinc & Electric Black
Extendable handle type
Aluminum grip
*EN 12195-2: 2000 certified



**2" Extendable Ratchet Buckle
RB51E-001**

Size: 2"/50mm
B.S: 5000kg
Finish: Zinc & Electric Black
Extendable handle type
Aluminum grip
*EN 12195-2: 2000 certified



**2" Extendable Ratchet Buckle
RB51E-005**

Size: 2"/50mm
B.S: 5000kg
Finish: Zinc & Electric Black
Extendable handle type
Aluminum grip
Reverse function



**2" Extendable A.B.S Ratchet Buckle
RB51ER-006**

Size: 2"/50mm
B.S: 5000kg
Finish: Zinc & Electric Black
Extendable handle type
Aluminum grip
Reverse-Gear



**1.5" A.B.S Ratchet Buckle
RB43R-001**

Size: 1.5"/35mm
B.S: 3000kg
Finish: Zinc & Electric Black
Aluminum grip



**3" Extendable Ratchet Buckle
RB76E-001**

Size: 3"/75mm
B.S: 10000kg
Finish: Zinc & Electric Black
Extendable handle type
Aluminum grip



**4" Extendable Ratchet Buckle
RB101E-001**

Size: 4"/100mm
B.S: 10000kg
Finish: Zinc & Electric Black
Extendable handle type
Aluminum grip

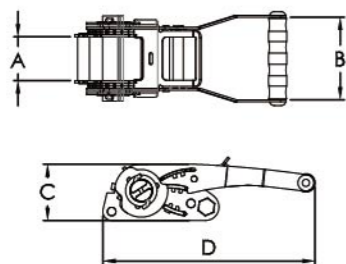

Item No.	A mm	B mm	C mm	D mm
RB51R-001	52	98	67	252
RB51ER-001	52	98	67	274/332
RB51ER-006	52	98	66	334/410
RB43R-001	42	66	68	252

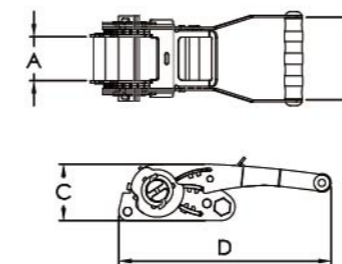

Item No.	A mm	B mm	C mm	D mm
RB51E-001	54	98	56	242/300
RB51E-005	52	98	52	280/338
RB76E-001	76	109	77	363/488
RB101E-001	101	134	77	363/488

RATCHET BUCKLE

Detachable Series

Ideal for trucks and long-way deliveries.
 Meet environment protection and energy saving trendy.
 Prevent unauthority off-load - the ratchet is not able to be loosened without handle.
 Space saving and weight reduction.
 Freely matching handle and ratchet-body as packs.

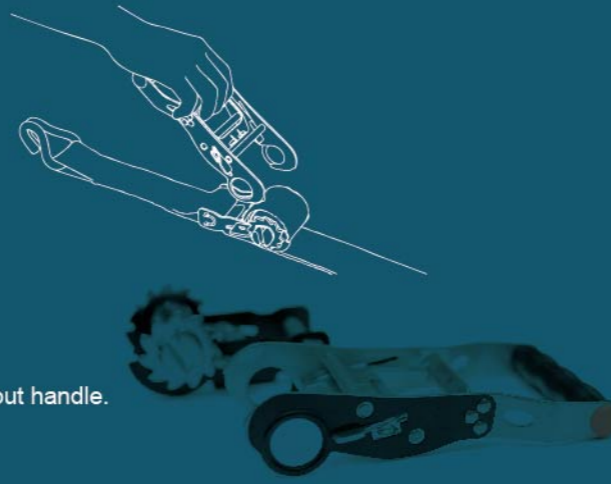

RATCHET BUCKLE

Retractable Series

Heavy-duty cargo lashing strap preferred.
 Long lever for better pre-tension force.
 Rotatable device for easier webbing adjustment and storage.
 Includes highly stretched fabric.



2" Detachable Ratchet Buckle
RB51AB-001
 Size: 2"/50mm
 B.S: 5000kg
 Finish: Zinc & Electric Black
 Removable handle type
 Ergonomic wide plastic grip
 *EN 12195-2: 2000 certified



2" Detachable Ratchet Buckle
RB51AB-004
 Size: 2"/50mm
 B.S: 5000kg
 Finish: Zinc & Electric Black
 Removable handle type
 Aluminum grip



2" Stainless Detachable Ratchet Buckle
RBS51AB-001
 Size: 2"/50mm
 B.S: 2500kg
 SUS 304
 Removable handle type
 Ergonomic wide plastic grip



1.5" Detachable Ratchet Buckle
RB43AB-001
 Size: 1.5"/35mm
 B.S: 3000kg
 Finish: Zinc & Electric Black
 Removable handle type
 Ergonomic wide plastic grip
 *EN 12195-2: 2000 certified



1.5" Stainless Detachable Ratchet Buckle
RBS43AB-001
 Size: 1.5"/35mm
 B.S: 1500kg
 SUS 304
 Removable handle type
 Ergonomic wide plastic grip



1.5" Detachable Ratchet Buckle
RB38AB-001
 Size: 1.5"/35mm
 B.S: 2000kg
 Finish: Zinc & Electric Black
 Removable handle type
 Ergonomic wide plastic grip

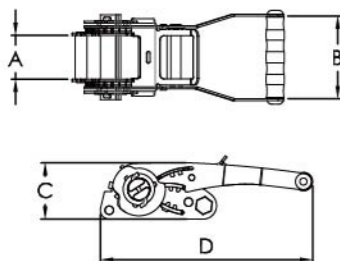

Item No.	A mm	B mm	C mm	D mm
RB51AB-001	54	98	57	211
RB51AB-004	54	98	57	211
RBS51AB-001	54	98	57	211
RB43AB-001	42	80	59	190
RBS43AB-001	42	80	44	175
RB38AB-001	42	80	42	172



2" Long Handle Retractable Ratchet Tie Down
RTDG51-002
 Size: 2"/50mm
 B.S: 5000kg
 Finish: Zinc & Electric Black
 Webbing length: 5M
 Long lever type
 Aluminum grip
 Double J hook ends



1.5" Long Handle Retractable Ratchet Tie Down
RTDG43-001
 Size: 1.5"/35mm
 B.S: 3000kg
 Finish: Zinc & Electric Black
 Webbing length: 3M
 Long lever type
 Aluminum grip
 Double J hook ends



1.5" Middle Handle Retractable Ratchet Tie Down
RTDG38-001
 Size: 1.5"/35mm
 B.S: 1800kg
 Finish: Zinc & Electric Black
 Webbing length: 3M
 Middle handle type
 Aluminum grip
 Double J hook ends



1" Rubber-handled Retractable Ratchet Tie Down
RTDG28-001
 Size: 1"/25mm
 B.S: 1200kg
 Finish: Yello Zinc
 Webbing length: 4.5M
 Middle handle type
 Rubber grip
 S hook ends



1" Retractable Ratchet Tie Down
RTDG28-002
 Size: 1"/25mm
 B.S: 1200kg
 Finish: Zinc & Electric Black
 Webbing length: 2M
 Middle handle type
 Aluminum grip
 S hook ends



1" Light Duty Retractable Ratchet Tie Down
RTDG24-001
 Size: 1"/25mm
 B.S: 550kg
 Finish: Yellow Zinc
 Webbing length: 4.8M
 S hook ends

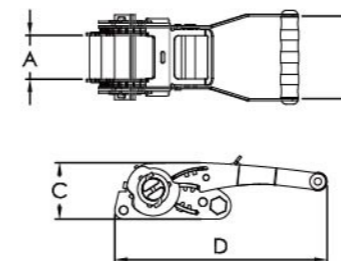

Item No.	A mm	B mm	C mm	D mm
RTD51G-002	53	98	85	350
RTD43G-001	41	80	82	280
RTD38G-001	40	80	63	215
RTD28G-001	27	90	78	168
RTD28G-002	30	60	64	148
RTD24G-001	27	38	75	135

RATCHET BUCKLE

Stainless Series

Ideal for commercial use.
UV exposure tested - non-rot or weaken.
Elegant outline and durable quality.

DURABLE, ELEGANT

RATCHET BUCKLE

Aluminum Series

Light-weight design.
Better free-crossion performance.
Elegant outline and durable quality.

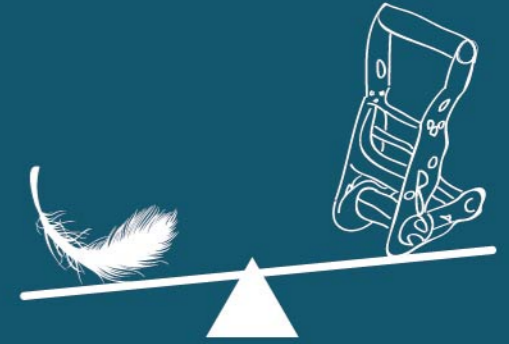

2" Stainless Long Lever Ratchet Bukcle
RBS51L-001
Size: 2"/50mm
B.S: 3000kg
SUS 304 / SUS 316
Long lever type
Aluminum grip



2" Stainless Ratchet Bukcle
RBS51M-001
Size: 2"/50mm
B.S: 3000kg
SUS 304 / SUS 316
Middle handle type
Aluminum grip



1.5" Long Handle Stainless Ratchet Bukcle
RBS43L-001
Size: 1.5"/35mm
B.S: 1500kg
SUS 304 / SUS 316
Long handle type
Aluminum grip



1.5" Middle Handle Stainless Ratchet Bukcle
RBS43M-001
Size: 1.5"/35mm
B.S: 1500kg
SUS 304 / SUS 316
Middle handle type
Aluminum grip



1.5" Short Handle Stainless Ratchet Bukcle
RBS43S-002
Size: 1.5"/35mm
B.S: 1500kg
SUS 304 / SUS 316
Short handle type
Aluminum grip



1.5" Light Duty Stainless Ratchet Bukcle
RBS38-001
Size: 1.5"/35mm
B.S: 1200kg
SUS 304 / SUS 316
Middle handle type
Aluminum grip



1" Stainless Ratchet Bukcle
RBS28-001
Size: 1"/25mm
B.S: 600kg
SUS 304 / SUS 316
Middle handle type
Aluminum grip



1" Light Duty Stainless Ratchet Bukcle
RBS24-001
Size: 1"/25mm
B.S: 400kg
SUS 304 / SUS 316



2" Aluminum Ratchet Bukcle
RBA51-001
Size: 2"/50mm
B.S: 900kg
Finish: Anodized
Short handle type



1.5" Aluminum Ratchet Bukcle
RBA38-001
Size: 1.5"/35mm
B.S: 800kg
Finish: Anodized
Middle handle type



1" Aluminum Ratchet Bukcle
RBA24-001
Size: 1"/25mm
B.S: 500kg
Finish: Anodized

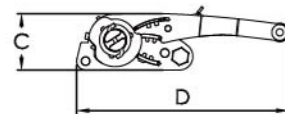
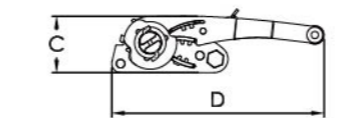
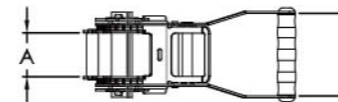

Item No.	A mm	B mm	C mm	D mm
RBS51L-001	56	98	56	229
RBS51M-001	56	98	60	197
RBS43L-001	41	80	56	170
RBS43M-001	41	56	56	235
RBS43S-002	41	56	58	153
RBS38-001	40	66	40	134
RBS28-001	31	57	37	131
RBS24-001	27	38	41	110

Item No.	A mm	B mm	C mm	D mm
RBA51-001	54	79	40	131
RBA38-001	42	66	40	133
RBA24-001	27	38	41	110

RATCHET BUCKLE

Ergonomic Rubber Grip Series

Heavy duty load securing preferred.
High visibility with colorful rubber handle.
Side rubber caps for better protection.

Comfort
Streamline Shape
Fashion



2" Ergonomic Rubber Handle Ratchet Buckle
RB51L-025

Size: 2"/50mm
B.S: 5000kg
Finish: Zinc & Electric Black
Long lever type
Rubber grip



2" Ergonomic Middle Handle Ratchet Buckle
RB51M-015

Size: 2"/50mm
B.S: 5000kg
Finish: Zinc & Electric Black
Middle handle type
Rubber grip



1.5" Ergonomic Light Duty Ratchet Buckle
RB38M-006

Size: 1.5"/35 mm
B.S: 1800kg
Finish: Zinc & Electric Black
Middle handle type
Rubber grip



1" Ergonomic Rubber Handle Ratchet Buckle
RB28-008

Size: 1"/25 mm
B.S: 1200kg
Finish: Zinc & Electric Black
Middle handle type
Rubber grip



1" Ergonomic Light Duty Ratchet Buckle
RB24-023

Size: 1"/25 mm
B.S: 800kg
Finish: Zinc & Electric Black
Rubber grip

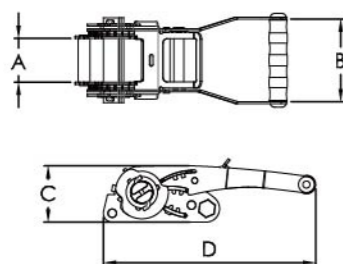

Item No.	A mm	B mm	C mm	D mm
RB51L-025	54	107	60	223
RB51M-015	54	107	54	205
RB38M-006	42	80	40	150
RB28-008	30	65	41	139
RB24-023	27	43	41	125

RATCHET BUCKLE

Conjoined Hook Series

Exclusive conjoined hook end design.
To replace webbing end and save cost.
Ease to operate and maintain.
All size available.

SIMPLE, EASIER AND COST DOWN



2" Middle Handle Ratchet Buckle with conjoined hook
RB51M-002C

Size: 2"/50mm
B.S: 5000kg
Finish: Zinc & Electric Black
Middle handle type
Aluminum grip
Exclusive hook end



1.5" Middle Handle Ratchet Buckle with Conjoined hook
RB43L-009C

Size: 1.5"/35mm
B.S: 3000kg
Finish: Zinc & Electric Black
Middle handle type
Rotatable plastic grip
Exclusive hook end



1.5" Straight Handle Ratchet Buckle with Conjoined hook
RB43M-003C

Size: 1.5"/35mm
B.S: 3000kg
Finish: Zinc & Electric Black
Straight handle type
Aluminum grip
Exclusive hook end



1.5" Rubber Handle Ratchet Buckle with Conjoined hook
RB38M-007C

Size: 1.5"/35mm
B.S: 2000kg
Finish: Zinc & Electric Black
Middle type
Rubber grip
Exclusive hook end



1" Middle Handle Ratchet Buckle with conjoined hook
RB28-005C

Size: 1"/25mm
B.S: 1200kg
Finish: Zinc & Electric Black
Middle handle type
Aluminum grip
Exclusive hook end



1" Once Forming Frame Ratchet Buckle with conjoined hook
RB28-024C

Size: 1"/25mm
B.S: 1200kg
Finish: Zinc & Electric Black
Handle and side panel once forming type
Exclusive hook end



1" Light Duty Ratchet Buckle with conjoined hook
RB24-020C

Size: 1"/25mm
B.S: 800kg
Finish: Yellow Zinc & Electric Black
Handle and side panel once forming type
Exclusive hook end

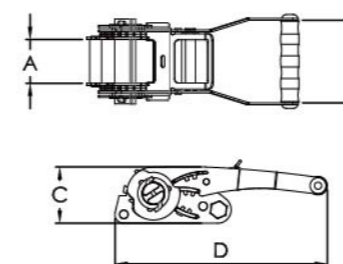

Item No.	A mm	B mm	C mm	D mm
RB51M-002C	56	98	60	271
RB43L-009C	41	80	56	235
RB43M-003C	41	56	56	235
RB38M-007C	42	80	40	190
RB28-005C	31	57	37	218
RB28-024C	30	59	41	173
RB24-020C	27	38	42	170

RATCHET BUCKLE

Traditional Series

Support various cargo control system.



3" Long Handle Ratchet Buckle
RB76-001
Size: 3"/75mm
B.S: 10000kg
Finish: Yellow Zinc
Long handle type
Aluminium grip



2" Long Handle Ratchet Buckle
RB51L-008
Size: 2"/50mm
B.S: 5000kg
Finish: Yellow Zinc
Long handle type
Aluminium grip



2" Economic Type Ratchet Buckle
RB51L1-010
Size: 2"/50mm
B.S: 3000kg
Finish: Yellow Zinc
Long handle type
Plastic grip
U-pin end



2" Long Handle Ratchet Buckle
RB51L-010
Size: 2"/50mm
B.S: 5000kg
Finish: Yellow Zinc & Electric Black
Long handle type
Plastic grip



2" Middle Handle Ratchet Buckle
RB51M-001
Size: 2"/50mm
B.S: 5000kg
Finish: Yellow Zinc
Middle handle type
Aluminium grip



2" Straight Handle Ratchet Buckle
RB51N-001
Size: 2"/50mm
B.S: 5000kg
Finish: Yellow Zinc
Straight handle type
Aluminium grip



2" Light Duty Ratchet Buckle
RB51S-003
Size: 2"/50mm
B.S: 2000kg
Finish: Zinc & Electric Black
Short handle type
Aluminium grip



1.5" Long Handle Ratchet Buckle
RB43L-001
Size: 1.5"/35mm
B.S: 3000kg
Finish: Yellow Zinc
Long handle type
Aluminium grip



1.5" Straight Handle Ratchet Buckle
RB43S-007
Size: 1.5"/35mm
B.S: 3000kg
Finish: Zinc & Electric Black
Long handle type
Aluminium grip



1.5" Light Duty Ratchet Buckle
RB38M-011
Size: 1.5"/35mm
B.S: 1800kg
Finish: Zinc & Electric Black
Middle handle type
Aluminium grip



1" Once Forming Frame Ratchet Buckle
RB28-010
Size: 1"/25mm
B.S: 1200kg
Finish: Yellow Zinc
Handle and side panel once forming type



1" Middle Handle Ratchet Buckle
RB28-023
Size: 1"/25mm
B.S: 1200kg
Finish: Zinc
Aluminium grip



1" Light Duty Ratchet Buckle
RB24-020
Size: 1"/25mm
B.S: 800kg
Finish: Yellow Zinc & Electric Black



3/4" Mini Ratchet Buckle
RB18-001
Size: 3/4"/15mm
B.S: 300kg
Finish: Zinc & Electric Black



1/2" Mini Ratchet Buckle
RB13-001
Size: 1/2"/10mm
B.S: 100kg
Finish: Zinc & Electric Black

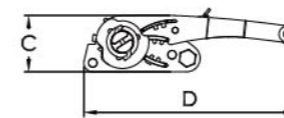

Item No.	A mm	B mm	C mm	D mm
RB76-001	80	112	77	320
RB51L-008	56	98	56	229
RB51L1-010	52	98	56	230
RB51L-010	56	98	56	229
RB51M-001	56	98	60	197
RB51N-001	56	70	58	170
RB51S-003	54	79	40	131
RB43L-001	41	80	56	170
RB43S-007	41	56	58	153
RB38M-011	42	66	40	133
RB28-010	30	59	41	118
RB28-023	31	57	37	131
RB24-020	27	38	41	110
RB18-001	20	29	30	92
RB13-001	15	24	30	83

Multi-function Super Ratchet Buckle

Roller Chain Binder

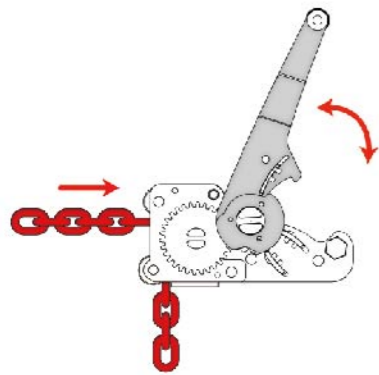

CHAIN

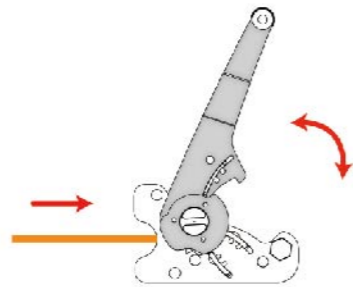

WEBBING



DETACHABLE



RATCHET TIE DOWN WITH A.B.S SYSTEM

Multi-function Super Ratchet Buckle (3 IN 1)

RLB-ABS-01

Size: 2"/50mm
 B.S: 2000kg
 Finish: Zinc & Electric Black
 Built-in A.B.S system
 Removable Lever Block
 Standard Ratchet Buckle

2T Roller Chain Binder

RCRB-001

Size: 5/8"
 0.75T Swivel Forged hook ends
 Includes of 90cm 2T Chain
 N.W.: 3.60 KG
 W.L.L: 750 KG
 B.S: 2250 KG
 PAWL Safety Lock
 Quick ratchet design is easy to tension and release.



0.5T Roller Chain Binder

RCRB-003

Size: 3/8"
 1/4T Swivel Forged hook ends
 Includes of 90cm 0.5T Chain
 N.W.: 1.38 KG
 W.L.L: 250 KG
 B.S: 750 KG
 PAWL Safety Lock
 Quick ratchet design is easy to tension and release.



1T Roller Chain Binder

RCRB-002

Size: 1/2"
 0.5T Swivel Forged hook ends
 Includes of 90cm 1T Chain
 N.W.: 2.27 KG
 W.L.L: 500 KG
 B.S: 1500 KG
 PAWL Safety Lock
 Quick ratchet design is easy to tension and release.

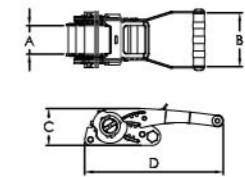

Item No.	A mm	B mm	C mm	D mm
RCRB-001	-	98	72	330
RCRB-002	-	81	64	230
RCRB-003	-	66	52	190

Ratchet Load Binder

Chain Binder

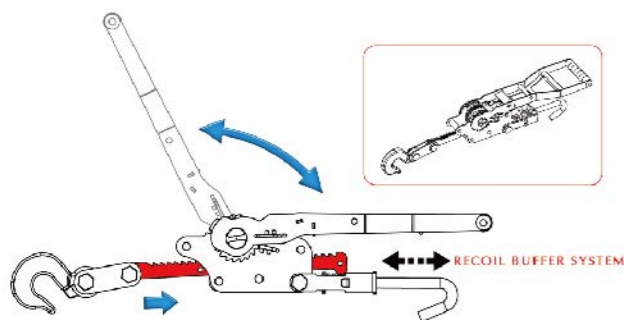

2" Multi-function Ratchet Load Binder

RLB-A-001

Size: 2"/50mm
 B.S: 4000kg
 Finish: Zinc & Electric Black
 Built-in recoil buffer system
 Plastic grip
 Forged hook in black plated

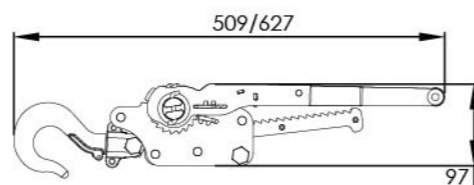
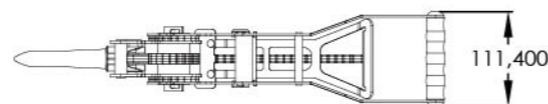

2T Chain Ratchet Buckle

CRB-001

Size: 7mm
 0.75T Swivel Forged hook ends
 Includes of 152cm 2T Chain
 N.W.: 4.76 KG
 W.L.L: 750 KG
 B.S: 2250 KG
 PAWL Safety Lock
 Quick ratchet design is easy to tension and release.



1T Chain Ratchet Buckle

CRB-002

Size: 5mm
 0.5T Swivel Forged hook ends
 Includes of 130cm 1T Chain
 N.W.: 2.68 KG
 W.L.L: 500 KG
 B.S: 1500 KG
 PAWL Safety Lock
 Quick ratchet design is easy to tension and release.

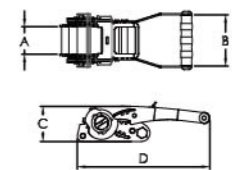

Item No.	A mm	B mm	C mm	D mm
CRB-001	-	98	72	330
CRB-002	-	81	64	230
CRB-003	-	66	52	190

0.5T Chain Ratchet Buckle

CRB-003

Size: 4mm
 1/4T Swivel Forged hook ends
 Includes of 124cm 0.5T Chain
 N.W.: 1.82 KG
 W.L.L: 250 KG
 B.S: 750 KG
 PAWL Safety Lock
 Quick ratchet design is easy to tension and release.



Ratchet Tie Down



2" Detachable Ratchet Tie Down
RTD51B-T2
 Size: 2"/50mm
 B.S: 5000kg
 Finish: Zinc & Electric Black
 Removable Handle
 Plastic grip
 Includes of 8M weather-resistant Polyester webbing
 Double J hook ends
 *EN 12195-2:2000 certified



Removable Handle



Rotatable Wave Rubber Grip



Patented Gear Structure



1 to 2 Blister Retail Package



2" A.B.S Ratchet Tie Down
RTD51R-001
 Size: 2"/50mm
 B.S: 5000kg
 Finish: Zinc & Electric Black
 Built-in A.B.S system
 Plastic grip
 Includes of 8M weather-resistant Polyester webbing
 Double J hook ends



2" Extendable Handle Ratchet Tie Down
RTD51E-003
 Size: 2"/50mm
 B.S: 5000kg
 Finish: Zinc & Electric Black
 Extendable handle type
 Includes of 8M weather-resistant Polyester webbing
 Double J hook ends
 *EN 12195-2:2000 certified



2" Standard Long Handle Ratchet Tie Down
RTD51L-025
 Size: 2"/50mm
 B.S: 5000kg
 Finish: Yellow Zinc
 Long handle type
 Aluminium grip
 Includes of 8M weather-resistant Polyester webbing
 Double J hook ends
 *EN 12195-2:2000 certified

2" Standard Long Handle Ratchet Tie Down
RTD51L-008
 Size: 2"/50mm
 B.S: 5000kg
 Finish: Yellow Zinc
 Long handle type
 Plastic grip
 Includes of 8M weather-resistant Polyester webbing
 Double J hook ends
 *EN 12195-2:2000 certified



2" Middle Handle Ratchet Tie Down
RTD51M-006
 Size: 2"/50mm
 B.S: 5000kg
 Finish: Yellow Zinc
 Middle handle type
 Aluminium grip
 Includes of 8M weather-resistant Polyester webbing
 Double J hook ends
 *EN 12195-2:2000 certified



2" Straight Handle Ratchet Tie Down
RTD51N-002
 Size: 2"/50mm
 B.S: 5000kg
 Finish: Yellow Zinc
 Straight handle type
 Aluminum grip
 Includes of 8M weather-resistant Polyester webbing
 Double J hook ends



2" Light Duty Ratchet Tie Down
RTD51S-003
 Size: 2"/50mm
 B.S: 2000kg
 Finish: Yellow Zinc
 Short handle type
 Steel grip
 Includes of 8M weather-resistant Polyester webbing
 Double J hook ends



1.5" Long Handle Ratchet Tie Down
RTD43L-001
 Size: 1.5"/35mm
 B.S: 3000kg
 Finish: Yellow Zinc
 Long handle type
 Aluminum grip
 Includes of 4.5M weather-resistant Polyester webbing
 Double J hook ends



1.5" Middle Handle Ratchet Tie Down
RTD43M-001
 Size: 1.5"/35mm
 B.S: 3000kg
 Finish: Yellow Zinc
 Middle handle type
 Aluminum grip
 Includes of 4.5M weather-resistant Polyester webbing
 Double J hook ends



1.5" Short Handle Ratchet Tie Down
RTD43S-001
 Size: 1.5"/35mm
 B.S: 3000kg
 Finish: Yellow Zinc
 Short handle type
 Aluminum grip
 Includes of 4.5M weather-resistant Polyester webbing
 Double J hook ends
 *EN 12195-2:2000 certified



1" Middle Handle Ratchet Tie Down
RTD28-001
 Size: 1"/25mm
 B.S: 1200kg
 Finish: Yellow Zinc
 Middle handle type
 Aluminum grip
 Includes of 4M weather-resistant Polyester webbing
 Double J hook ends
 *EN 12195-2:2000 certified



1" Once Forming Frame Ratchet Tie Down
RTD28-002
 Size: 1"/25mm
 B.S: 1200kg
 Finish: Yellow Zinc
 Handle and side panel once forming type
 Includes of 4M weather-resistant Polyester webbing
 Double J hook ends



1" Light Duty Ratchet Tie Down
RTD24-001
 Size: 1"/25mm
 B.S: 800kg
 Finish: Yellow Zinc
 Includes of 4M weather-resistant Polyester webbing
 Double J hook ends



3/4" Mini Ratchet Tie Down
RTD18-001
 Size: 3/4"/15mm
 B.S: 300kg
 Finish: Zinc & Electric Black
 Includes of 2M weather-resistant Polyester webbing
 S hook ends



1/2" Mini Ratchet Tie Down
RTD13-001
 Size: 1/2"/10mm
 B.S: 100kg
 Finish: Zinc & Electric Black
 Includes of 2M weather-resistant Polyester webbing
 S hook ends

Lever Block

Lever Block is a universal, manual hoist for lifting, tensioning and lashing in any direction. Short Hand lever with rubber grip



0.25T Lever Block

LBK-001

Capacity: 0.25T
Standard Lift: 1M
Chain length: 90cm
Swivel forged hook ends



0.5T Lever Block

LBK-002

Capacity: 0.5T
Standard Lift: 1M
Chain length: 90cm
Swivel forged hook ends



1T Lever Block

LBK-003

Capacity: 1T
Standard Lift: 1.5M
Chain length: 90cm
Swivel forged hook ends



2T Lever Block

LBK-004

Capacity: 2T
Standard Lift: 1.5M
Chain length: 90cm
Swivel forged hook ends

Cam Buckle



1" Cam Buckle
CB-CAM-01BK

Size: 1"/25mm
Material: Alloy Steel
B.S: 500kg
Finish: Electric black plated
Optional Color Bottom
Scratch proof pad

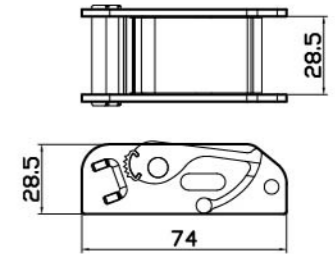

1" Cam Buckle
CB-CAM-01BK01

Size: 1"/25mm
Material: Zinc Alloy
B.S: 250kg
Finish: Electric black plated

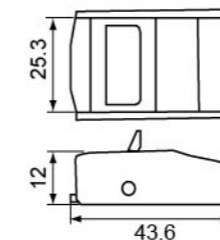

1" Cam Buckle
CB-CAM-01ZP

Size: 1"/25mm
Material: Zinc Alloy
B.S: 350kg
Finish: Zinc plated

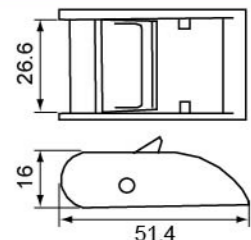

1.5" Cam Buckle
CB-CAM-015Z-03Z-ZP

Size: 1.5"/35mm
Material: Zinc Alloy
B.S: 680kg
Finish: Zinc plated

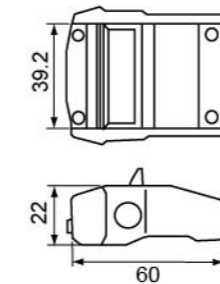

2" Cam Buckle
CB-CAM-02BK01

Size: 2"/50mm
Material: Zinc Alloy
B.S: 1200kg
Finish: Electric black plated

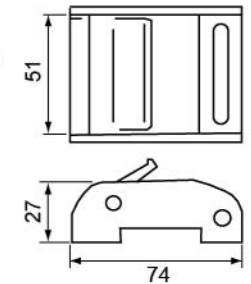

Stamping Parts

Precision Punching Machine

PRECISION PUNCHING MACHINING



Flat hook-01
FTH-001

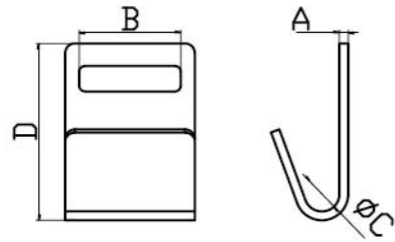

Item No.	A mm	B mm	C mm	W.L.L (kg)
F01D-025025052	25	52	2.5	1000
F01D-051045092	51	92	4.5	5000

*W.L.L=Working Load Limit



Flat hook-02
FTH-002

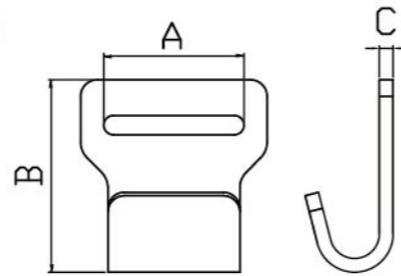

Item No.	A mm	B mm	C mm	W.L.L (kg)
F01D-031023029	31	29	2.3	500
F01D-040050065	40	75	5	1500
F01D-051050070	51	70	5	4000

*W.L.L=Working Load Limit



Twist Snap Hook
FTH-003

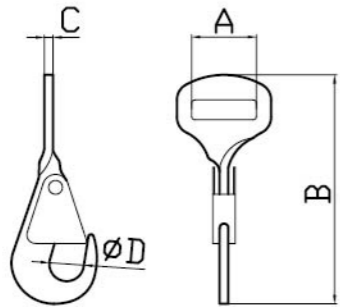

Item No.	A mm	B mm	C mm	D mm	W.L.L (kg)
FR66P-038050132	38	132	5	20	3000
FR66P-050060155	50	155	6	24	5000

*W.L.L=Working Load Limit



2" Delta Flat Hook
FTH-004

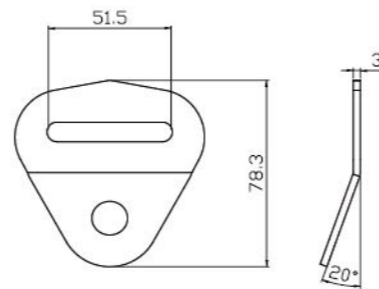

Stamped Buckle-01
STP-001

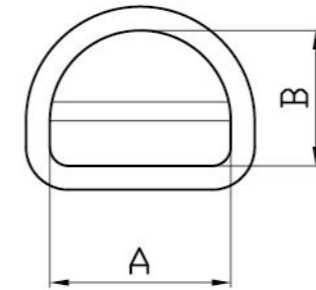

Item No.	A mm	B mm
FH44-061050062	45	45
FH44-06930542	54	54



Stamped Buckle-02
STP-002

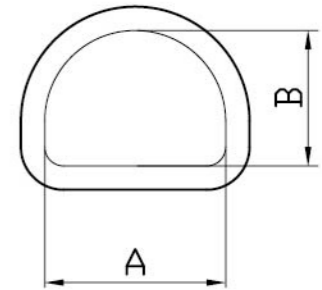

Item No.	A mm	B mm
FH44-0610562	45	45
FH44-06200478	47	33
FH44-0685068	49	48.5



Stamped Buckle-03
STP-003

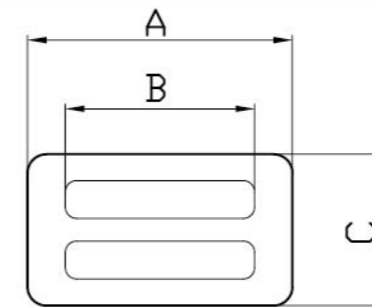

Item No.	A mm	B mm	C mm
FH44-0473028022	47.3	38.2	22
FH44-0500280380	49	38	38
FH44-060040030	60	46	30



Stamped Buckle-04
STP-004

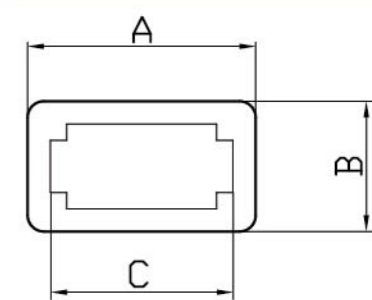

Item No.	A mm	B mm	C mm
FH44-063042	63	45	42
FH44-075045	75	53	45



Stamped Buckle-05
STP-005

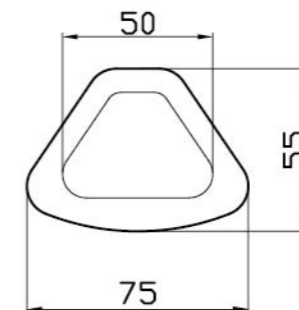

Ring

Practised molding team & precision punching machining
Your best partner for OEM/ODM project



SPEEDY & STABLE
TIME IS MONEY! AUTOMATIC WIRE FORMING MACHINE
PROVIDED QUICK DELIVERY

Buckle

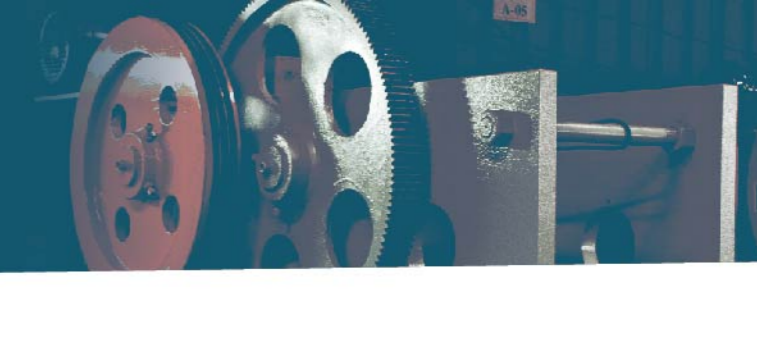

SPEEDY & STABLE
TIME IS MONEY! AUTOMATIC WIRE FORMING MACHINE
PROVIDED QUICK DELIVERY



D Ring
RING-01



D Ring with tube
RING-02

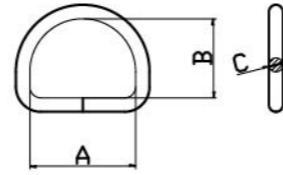

Item No.	A mm	B mm	C mm	B.S (kg)
RD04-025047030	25	30	4.7	1500
RD04-025063032	25	32	6.3	1500
RD04-044063042	44	4	6.3	1800

Item No.	A mm	B mm	C mm	B.S (kg)
RD04-050080060	50	60	8	2300
RD04-051063047	51	47	6.3	2300



Wire Buckle
BW01

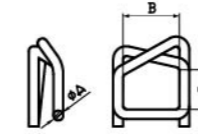

Item No.	A mm	B mm	C mm	W.L.L (1bs)
BW01-009030019	3	19	9	480
BW01-013030019	3	19	13	480
BW01-016030025	3	25	16	680
BW01-016040025	4	25	16	680
BW01-019040025	4	25	19	930
BW01-019050025	5	25	19	950
BW01-027060027	6	27	27	1800
BW01-030070035	7	35	30	2500

*W.L.L=Working Load Limit



Lap Link
LK01



Item No.	A mm	B mm	Item No.	A mm	B mm
L01-035019	35	19	L01-063051	63	51
L01-040019	40	19	L01-080038	80	38
L01-050025	50	25	L01-095051	95	51
L01-060032	60	32	L01-120064	120	64
L01-060038	60	38			



Waisted Ring
RING-03

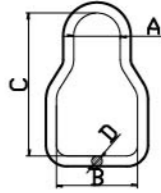

Item No.	A mm	B mm	C mm	D mm
WH08-050026042	11	26	42	5
WH08-063028061	22	28	61	6.3



O Ring
RING-04

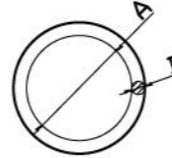

Item No.	A mm	B mm	Item No.	A mm	B mm
RO01-015030	15	3	RO01-035050	35	5
RO01-019030	19	3	RO01-038060	38	6
RO01-020040	20	4	RO01-040040	40	4
RO01-025040	25	4	RO01-050080	50	8
RO01-025050	25	5	RO01-055060	55	6
RO01-028050	28	5	RO01-065090	65	9
RO01-030050	30	5	RO01-076080	76	8



Eye Buckle/One Way Buckle
RR02

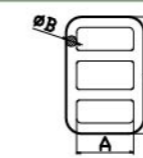

Item No.	A mm	B mm	C mm
RR02-045110110	45	11	110
RR02-055110115	55	11	115



Rave Hook
WH03

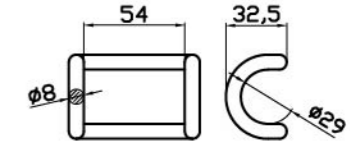

Triangle Ring
RING-05

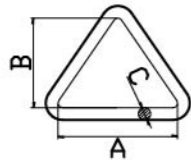

Item No.	A mm	B mm	C mm	B.S (kg)
RD05-026060034	26	34	6	1000
RD05-053063045	53	44.5	6.3	2200
RD05-050110048	50	48	11	3800
RD05-068011050	68	50	11	5000
RD05-070080062	70	62	8	-



Oval Ring
RING-06

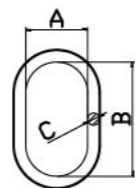

Item No.	A mm	B mm	C mm
RA01-008050025	8	28	5
RA01-013050051	13	51	5
RA01-013080605	13	60.5	8
RA01-030115051	30	51	11.5



Adjuster Buckle
Buckle-01
SUS 304

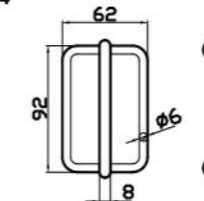

Buckle with Dual Anti-slip Adjuster
Buckle-03
SUS 304

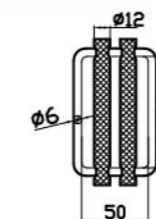

Buckle with Anti-slip Adjuster
Buckle-02

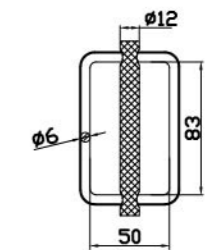

Tongue Buckle
Buckle-04

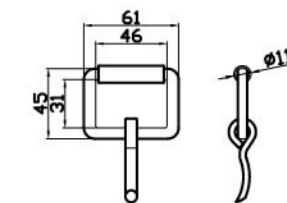

Rectangle Ring
RING-07

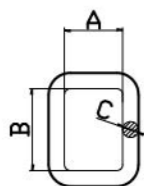

Item No.	A mm	B mm	C mm	Item No.	A mm	B mm	C mm
RR01-0127025095	12.7	9.5	2.5	RR01-025032051	50.8	25.4	3.2
RR01-019030095	19	9.5	3	RR01-051040020	51	20	4
RR01-022040040	22	40	4	RR01-051050010	51	10	4
RR01-025020065	25	6.5	2	RR01-051060032	51	32	6
RR01-038030095	38	9.5	3	RR01-070050025	70	25	5

Hook



Bungee Hook-01
SPR02
SUS304

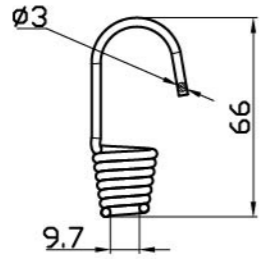

Bungee Hook-02
SPR03
SUS304

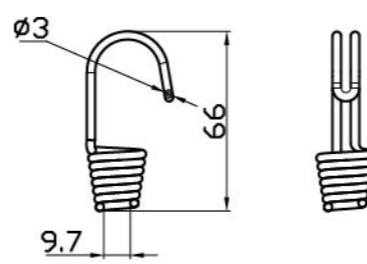

Snap Hook
SH04P

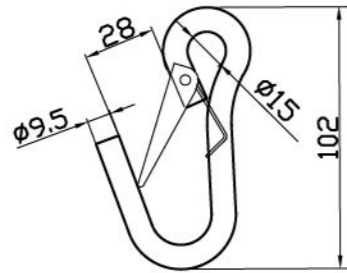

J Shaped Tie Hook
J16-060060Z

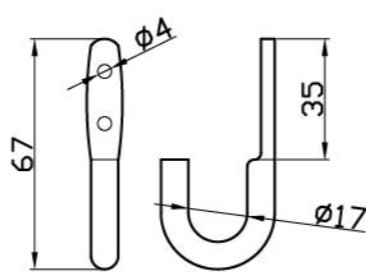

Spring Hook
WH08P

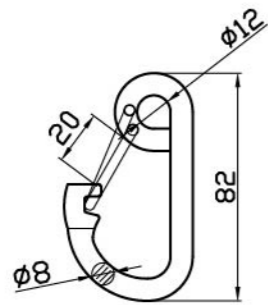

Spring Hook
SPRING HOOK-01

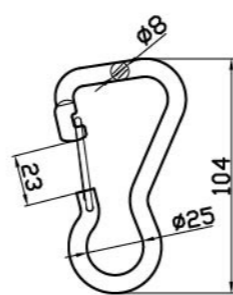

Spring Hook
SPRING HOOK-02

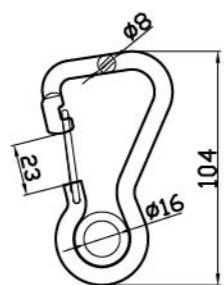

Spring Hook
SPRING HOOK-03

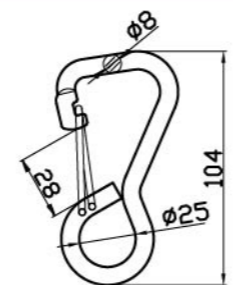

Snap Hook with Eyelet
SNAP HOOK-01

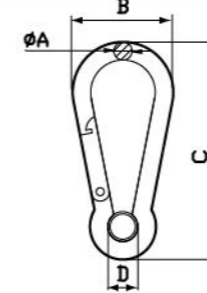

Item No.	A mm	B mm	C mm	D mm	Open mm	W.L.L (lbs)
SH01X-040040	4	20	40	5	7	80
SH01X-050050	5	25	50	5	7	100
SH01X-060060	6	30	60	5	8	140
SH01X-070070	7	35	70	7	8	200
SH01X-080080	8	40	80	10	9	250
SH01X-090090	9	45	90	10	10	280
SH01X-100100	10	50	100	13	11	400
SH01X-110120	11	527	120	13	16	500
SH01X-120140	12	67	140	15	19	600
SH01X-130160	13	74	160	17	25	700
SH01X-140180	14	86	180	17	35	900

*W.L.L=Working Load Limit



Snap Hook
SNAP HOOK-02

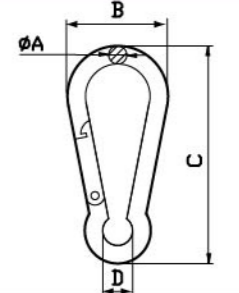

Item No.	A mm	B mm	C mm	D mm	Open mm	W.L.L (lbs)
SH01-040040	4	20	40	5	7	80
SH01-050050	5	25	50	5	7	100
SH01-060060	6	30	60	5	8	140
SH01-070070	7	35	70	7	8	200
SH01-080080	8	40	80	10	9	250
SH01-090090	9	45	90	10	10	280
SH01-100100	10	50	100	13	11	400
SH01-110120	11	527	120	13	16	500
SH01-120140	12	67	140	15	19	600
SH01-130160	13	74	160	17	25	700
SH01-140180	14	86	180	17	35	900

*W.L.L=Working Load Limit



Quick Link
LQ01

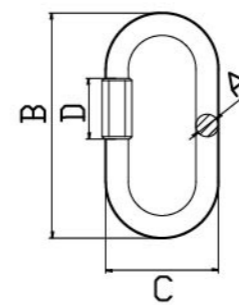

Item No.	A mm	B mm	C mm	D mm	W.L.L (lbs)
LQ01-017050036	3.5	36.5	17	5	175
LQ01-019055040	4	40	19.5	5.5	500
LQ01-023050048	5	49	23	6.5	650
LQ01-026060057	6	58	26.5	7.5	875
LQ01-030070065	7	65	30.5	8.5	1200
LQ01-034080076	8	75	33.5	10.5	1525
LQ01-035090082	9	82	35	11.5	1975
LQ01-040100090	10	90	40.5	12.5	2300
LQ01-047120107	12	107	47.5	14.5	2500
LQ01-054140125	14	125	54.5	17	2800

*W.L.L=Working Load Limit

J Hook



Double J hook - Zinc
J-Hook-01

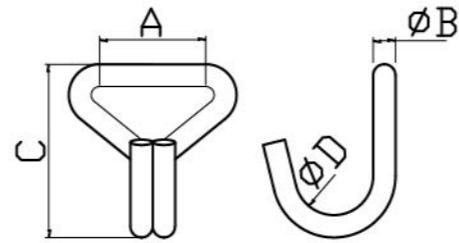

Item No.	A mm	B mm	C mm	D mm	B.S (kg)
J01-015047042	15	4.7	42	-	200
J01-025047063	25	4.7	63	13	900
J01-025063047	25	6.3	47	10	1650
J01-025070060	25	7	60	20	1800
J01-027070054	27	7	54	26.5	1400
J01-025080080	28	8	80	20	1800
J01-030063050	30	6.3	50	10	1360
J01-038090088	38	9	88	20	3300
J01-051050063	51	3	35	6	300
J01-051080054	51	8	54	20	2000
J01-051090085	51	9	85	20	2000
J01-051095085	51	9.5	85	20	3500
J01-051110085	51	11	85	23	4300
J01-051110106	51	11	106	23	4500
J01-051115085	51	11.5	85	23	5000
J01-051120085	51	12	85	23	5000
J01-051122103	51	12.2	103	23	5000
J01-076160121	76	16	121	20	10000
J01-076160135	76	16	135	20	10000
J01-076160140	76	16	140	20	10000
J01-101160143	101	16	143	20	10000



Double J hook - Yellow Zinc
J-Hook-02



Double J hook - PVC Black
J-Hook-03



Double J hook - Matt Yellow Zinc
J-Hook-04



Stainless Double J hook
J-Hook-05
SUS 304/SUS 316

Item No.	A mm	B mm	C mm	D mm	B.S (kg)
J01-015047042SP	15	4.7	42	-	200
J01-025047042SP	25	4.7	42	9	500
J01-025047063SP	25	4.7	63	13	900
J01-025060047SP	25	6	47	10	1000
J01-025063047SP	25	6.3	47	10	1650
J01-025063050SP	25	6.3	50	9	1800
J01-025070060SP	25	7	60	20	1800

Item No.	A mm	B mm	C mm	D mm	B.S (kg)
J01-027070054SP	27	7	54	26.5	1400
J01-038095085SP	38	9.5	85	20	1500
J01-038100085SP	38	10	85	20	1300
J01-051095085SP	51	9.5	85	20	1500
J01-051110085SP	51	11	85	23	1500
J01-051120085SP	51	12	85	23	2500



Finger Profile Hook
J-Hook-06

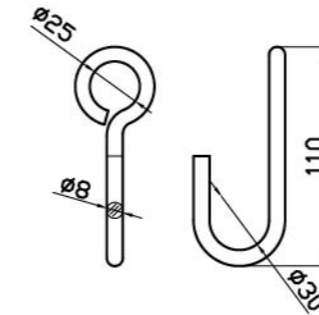

Welding Tube Profile Hook
J-Hook-08

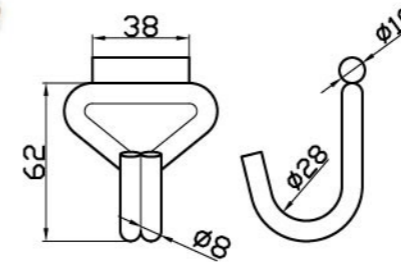

J Hook
J-Hook-10

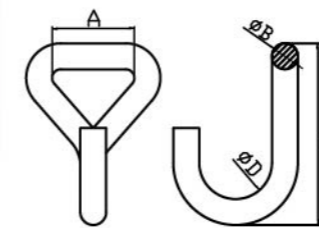

Item No.	A mm	B mm	C mm	D mm	B.S (kg)
J04-038120090	38	12	90	20	3000
J04-0475150105	47.5	15	105	20	5000
J04-051150130	51	15	130	15	5000



Welding Tube Single Hook
J-Hook-07

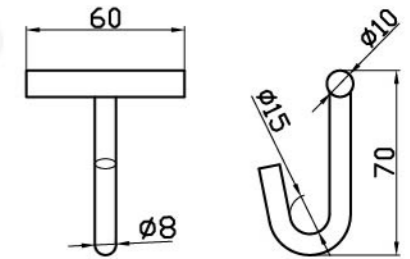

Eye Hook
J-Hook-09

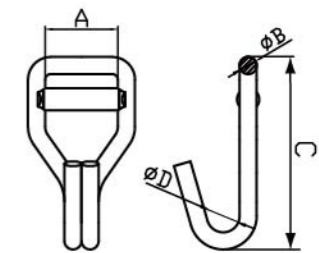

Item No.	A mm	B mm	C mm	D mm	B.S (kg)
J11-038095115	38	9.5	115	-	3000
J11-050120137	50	12	137	23	5000



Hook and Keeper
J-Hook-11

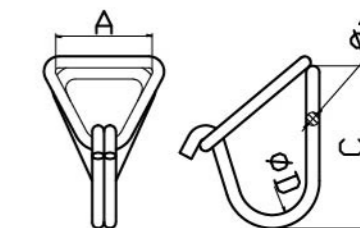

Item No.	A mm	B mm	C mm	D mm	B.S (kg)
J07R-038070086Y	38	7	86	20	2000
J07R-051085105Y	51	8	105	40	5000

S Hook



S Hook
S HOOK-01

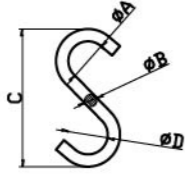

Item No.	A mm	B mm	C mm	D mm
S06-009025028	12	2.5	28	12
S06-011050039	12	5	39	12
S06-016050056	14	5	56	14
S06-018062062	18	6.2	62	18
S06-022095082	23	9.5	82	23
S06-035040085	34.5	4	85	34.5



S Hook - PE Black coating
S HOOK-03



S Hook - PVC Black coating
S HOOK-03

Item No.	A mm	B mm	C mm	D mm	B.S (kg)
S01-025070104	25	7	104	26	750
S01-025080105	25	8	105	26	900
S01-025080118	25	8	118	30	900
S01-025090110	25	9	110	25	900
S01-025105122	25	10.5	122	28	1500
S01-027295119	27	9.5	119	27	1200
S01-027100122	27	10	122	33	1500
S01-030130148	30	13	148	-	2500



S Hook with Spring
S HOOK-04

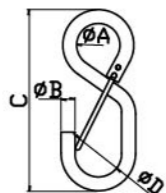

S Hook
S HOOK-02

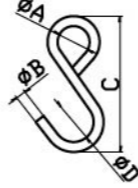

Item No.	A mm	B mm	C mm	D mm
S03-008030027	8	3	27	-
S03-010030035	10	3	35	-
S03-016050068	16	5	68	-
S03-018055072	18	5.5	72	-
S03-022080083	22	8	83	25
S03-022080090	22	8	90.5	28
S03-023073089	23	7.3	89	27
S03-025100099	25	10	99	31



S Hook - PVC Blue coating
S HOOK-03

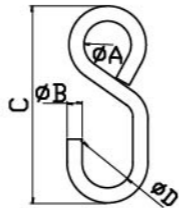

Item No.	A mm	B mm	C mm	D mm	B.S (kg)
S01-025070104SP	25	17	104	26	250
S01-025080105SP	25	8	105	26	250
S01-025090110SP	25	9	110	25	450
S01-025130130SP	25	13	130	29	1900
S01-027095119SP	27	9.5	119	27	750

*SUS 304/SUS 316

Item No.	A mm	B mm	C mm	D mm
S01P-025080105	25	8	105	26
S01P-025080119	25	8	119	26
S01P-027095119	27	9.5	119	27
S01P-031080113	31	8	113.5	26

Bolt

Bolt/Stud
Bolt-01

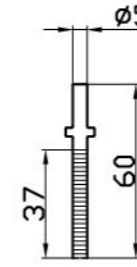

Bolt/Eyelet Screw
Bolt-02

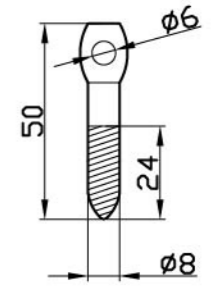

Bolt/Eyelet Stud
Bolt-03

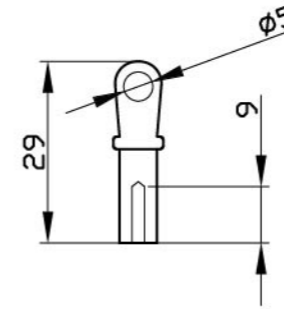

Bolt/Eyelet Stud
Bolt-04

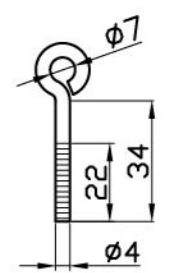

Bolt/Stud Hook
Bolt-05

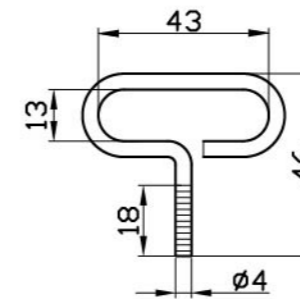

Fitting



Double Stud Fitting
SF202P-062018025

B.S: 2300kg
Finish: Zinc

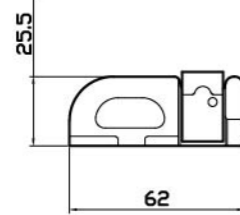

Double Stud Fitting with O ring
SF202-062018025TZ-O

B.S: 2300kg
Finish: Zinc

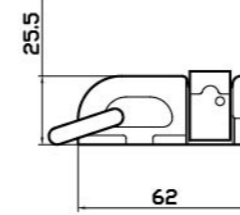

End Fitting
EF101-051YY

B.S: 2300kg
Finish: Yellow Zinc

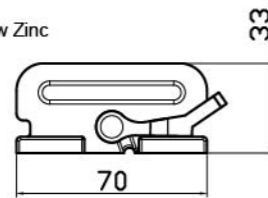

Forged End Fitting
EF103-02540127061Y

B.S: 2300kg
Finish: Yellow Zinc

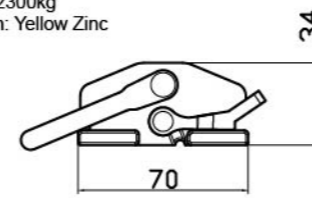

Single Stud Fitting
SF102P-0286050

B.S: 1300kg
Finish: Anodized

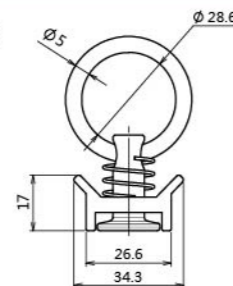

Forging

Cold Forming and Cold Forging Parts
Building, Auto Parts, Marine Accessories
PPAP (Production Part Approval Process)
IMDS (International Material Data System)
Customization/ Please send your spec. or drawing to us.

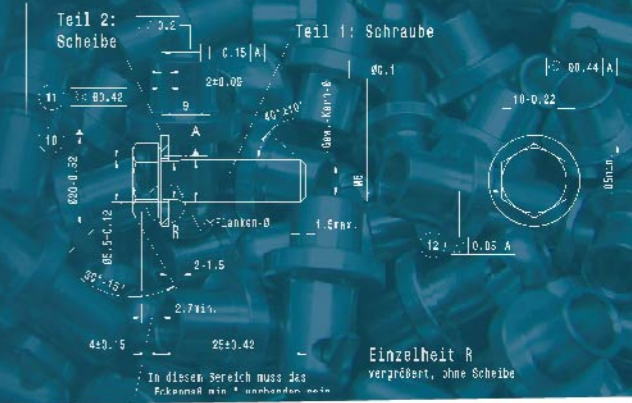

FORGING-PART01

Customization / Please send your spec. or drawing to us.

- *Bush
- *Fastener
- *Rivet

Material(*Options): Alloy Steel/ *Aluminum/ *Stainless Steel
Surface Treatment(*Options): Zinc/ *Yellow Zinc/ *Nickel Plating/ *Chromium Plating



FORGING-PART02

Customization/ Please send your spec. or drawing to us.

- *Bush
- *Metal Hardware
- *Bracket

Material(*Options): Alloy Steel/ *Aluminum/ *Stainless Steel
Surface Treatment(*Options): Zinc/ *Yellow Zinc/ *Nickel Plating/ *Chromium Plating



FORGING-PART03

Customization/ Please send your spec. or drawing to us.

- *Collar
- *Eye Blot
- *Cap

Material(*Options): Alloy Steel/ *Aluminum/ *Stainless Steel
Surface Treatment(*Options): Zinc/ *Yellow Zinc/ *Nickel Plating/ *Chromium Plating



FORGING-PART04

Customization/ Please send your spec. or drawing to us.

- *Collar
- *Eye Blot

Material(*Options): Alloy Steel/ *Aluminum/ *Stainless Steel
Surface Treatment(*Options): Zinc/ *Yellow Zinc/ *Nickel Plating/ *Chromium Plating

Fall Protection

TECHNOLOGY INFORMATION

STRICT QUALITY TEST METHOD AND LOADING TEST AT WIN CHANCE
CARABINER & HOOKS

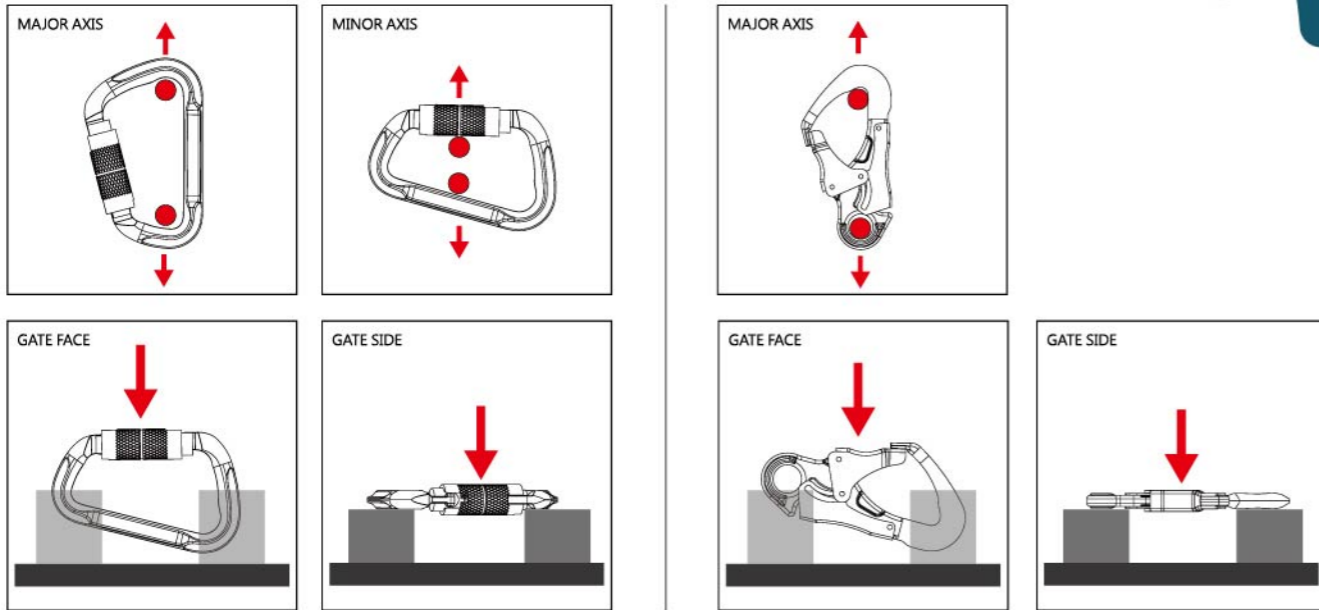

MINIMUM REQUIREMENTS AS OUTLINED FOR HOOKS AND CARABINERS PER SATNDRAD :

Standard	CSA Z259.12-01	CSA Z259.12-11	ANSI 359.1-1999	ANSI/ASSE Z359.12-2009	EN 362:2004	NFPA 1983-2006
Major Axis	5000 lbs (22.2kN)	5000 lbs (22.2kN)	5000 lbs (22.2kN)	5000 lbs (22.2kN)	4500 lbs (20kN)	***
Gate Face	220 lbs (1kN)	3600 lbs (16kN)	220 lbs (1kN)	3600 lbs (16kN)	220 lbs (1kN)	N/A
Side Load	350 lbs (1.55kN)	3600 lbs (16kN)	350 lbs (1.55kN)	3600 lbs (16kN)	350 lbs (1.55kN)	N/A
Minor Axis	N/A	3600 lbs (16kN)	N/A	3600 lbs (16kN)	**	***

* New Standard require Minor Axis Loading for connectors with non-integral eyes.

** EN: Basic Connector 1575 lbs(7kN); Multi Use Connector 3378lbs(15kN)

*** NFPA: Light Use... Major Axis gate closed 8922 lbs(39.7kN);
Major Axis gate open 2473 lbs(11kN); Minor Axis 2473 lbs(11kN)

www.winchance.tw

R&D TEAM



With current facilities, Win Chance already had professional production lines of steel alloy, stainless steel and aluminum alloy as our back up so we can achieve customer request on Carabiner, Safety Hooks, Safety Buckles and provided customer OEM and ODM items for their own design concept and meet their safety requirements. After 4 years striving in fall protection field, we successfully gain worldwide customer trust and support customer produce various new functional demands with reliable quality. These fruitful results stepped up our aluminum forging production line to be built this January 2016, Win Chance now became a multiple supplier to offer more application for our business partner.

WIN CHANCE DESIGN CONCEPT

SHAPE

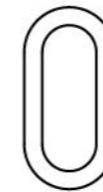

OVAL
C Carabiner /
Design for lower loads.



Regular D
D Carabiner / Designed to
orient the load in a
predetermined direction on
the connector's body.



Asymmetrical D
V or D1 Carabiner / V Shape is
offset or curved to one side allows
a climber to use the Munter Hitch
for belaying without the rope
getting stuck or jammed.



WAIST
Waist Carabiner is to design to
secure rope at bottom. To make
sure the loading force is in same
horizontal.



SPECIAL
Captive Eye Carabiner / Connectors
with complex shapes for a
particular purpose; to be connected
directly to a special anchor type.

GATE

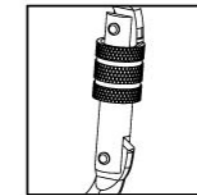

SCREW-LOCK

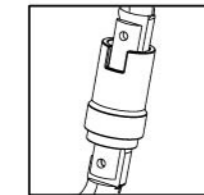

KWIK-LOCK

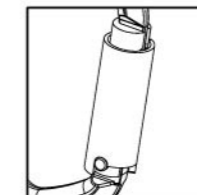

TRIPLE-LOCK

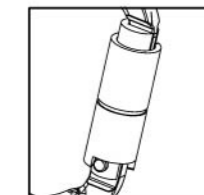

TWIST-LOCK

NOSE



Snag Free

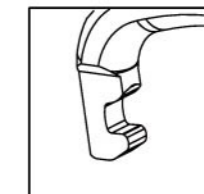

Regular

CAPTIVE PIN

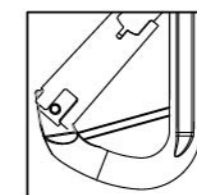

Steel Carabiner



C Carabiner
CBR-S-003

Min. Breaking Strength: 23kN/5000lbs
Alloy Steel
Screw Lock

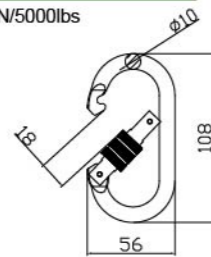

C Carabiner
CBR-S-005

Min. Breaking Strength: 23kN/5000lbs
Alloy Steel
Kwiklock

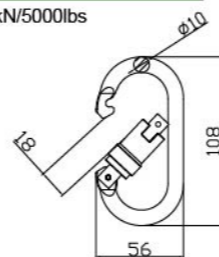

C Carabiner
CBR-SP-001

Min. Breaking Strength: 23kN/5000lbs
Stainless Steel
Kwiklock

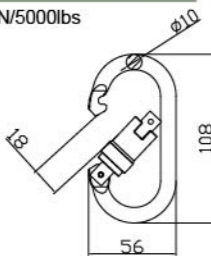

C Carabiner
CBRA-S10-001

Min. Breaking Strength: 23kN/5000lbs
Alloy Steel
Twist Lock

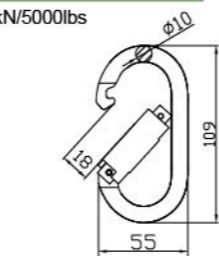

D Carabiner
CBRD-S-001

Min. Breaking Strength: 23kN/5000lbs
Alloy Steel
Screw Lock

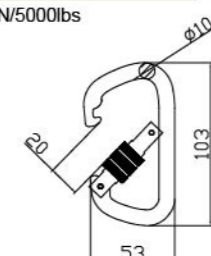

D Carabiner
CBRD-S-007

Min. Breaking Strength: 23kN/5000lbs
Alloy Steel
Kwiklock

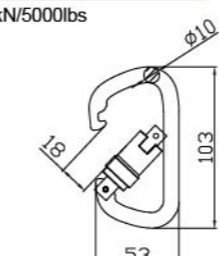

D Carabiner
CBRD-SP-001

Min. Breaking Strength: 23kN/5000lbs
Stainless Steel
Kwiklock

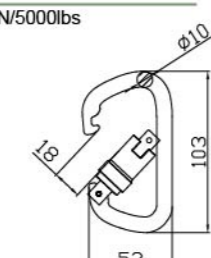

D Carabiner
CBRAD-S10-001

Min. Breaking Strength: 23kN/5000lbs
Alloy Steel
Twist Lock

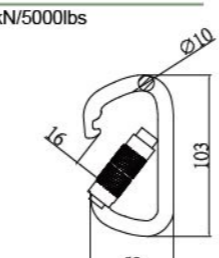

D Carabiner
CBRAD-S11-001

Min. Breaking Strength: 23kN/5000lbs
Alloy Steel
Twist Lock

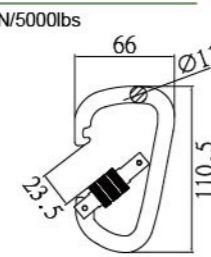

D Carabiner
CBRAD-F-002

Min. Breaking Strength: 40kN/8900lbs
Forged Alloy Steel
Twist Lock

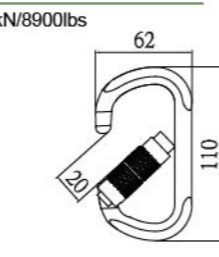

D1 Carabiner
CBRD1-S-001

Min. Breaking Strength: 23kN/5000lbs
Alloy Steel
Screw Lock

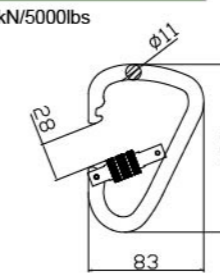

D1 Carabiner
CBRD1-S-005

Min. Breaking Strength: 23kN/5000lbs
Alloy Steel
Kwiklock

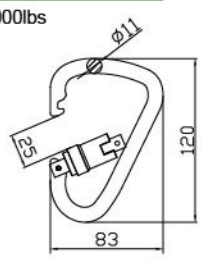

D Carabiner
CBRD-S-001

Min. Breaking Strength: 23kN/5000lbs
Alloy Steel
Screw Lock

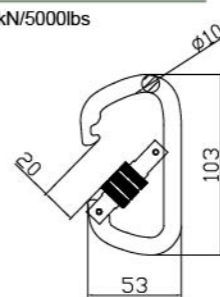

D Carabiner
CBRD-S-007

Min. Breaking Strength: 23kN/5000lbs
Alloy Steel
Kwiklock

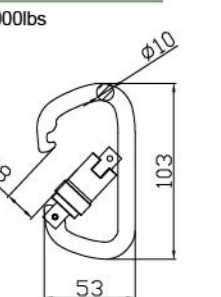

D1 Carabiner
CBRAD1-S11-001

Min. Breaking Strength: 23kN/5000lbs
Alloy Steel
Twist Lock

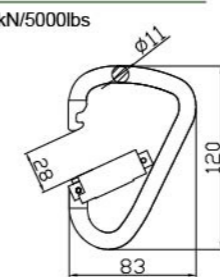

D1 Carabiner
CBRTD1-F-002

Min. Breaking Strength: 30kN/6500lbs
Forged Alloy Steel
Triple Lock

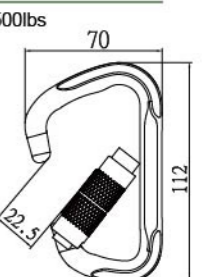

D1 Carabiner
CBRD1-F-003

Min. Breaking Strength: 30kN/6500lbs
Forged Alloy Steel
Triple Lock

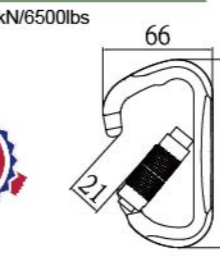

D1 Carabiner
CBRTD1-F-004

Min. Breaking Strength: 41kN/9000lbs
Forged Alloy Steel
Triple Lock

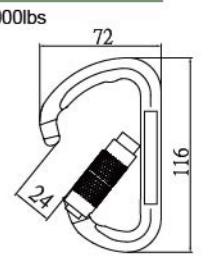

D1 Carabiner
CBRAD1-S11-002

Min. Breaking Strength: 23kN/5000lbs
Alloy Steel
Twist Lock

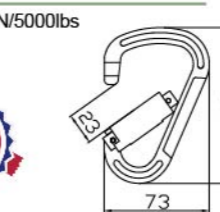

Steel Carabiner



WAIST Carabiner
SH01CX-010119

Min. Breaking Strength: 23kN/5000lbs
Alloy Steel
Screw Lock



WAIST Carabiner
SH01KX-100120

Min. Breaking Strength: 23kN/5000lbs
Alloy Steel
Kwiklock

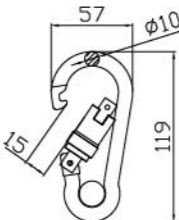

WAIST Carabiner
SH01TX-F-001

Min. Breaking Strength: 30kN/6500lbs
Forged Alloy Steel
Triple Lock

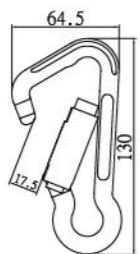

Medium Swivel Carabiner
CBRR-S-002

Min. Breaking Strength: 23kN/5000lbs
Alloy Steel
Kwiklock

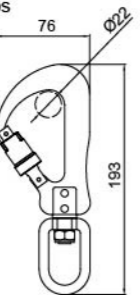

Swivel Carabiner
CBRR-F-001

Min. Breaking Strength: 30kN/6500lbs
Forged Alloy Steel
Twist Lock

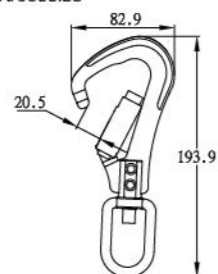

WAIST Carabiner
SH01CX-100120SP-1

Min. Breaking Strength: 23kN/5000lbs
Stainless Steel
Screw Lock

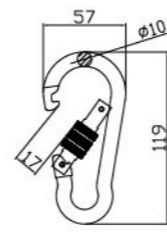

WAIST Carabiner
SH01AX-100120

Min. Breaking Strength: 23kN/5000lbs
Alloy Steel
Twist Lock

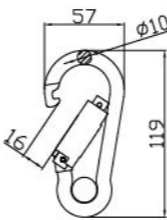

Large Swivel Carabiner
CBRR-S-001

Min. Breaking Strength: 23kN/5000lbs
Alloy Steel
Kwiklock

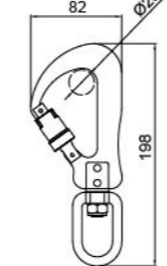

Small Swivel Carabiner
CBRR-S-003

Min. Breaking Strength: 23kN/5000lbs
Alloy Steel
Kwiklock

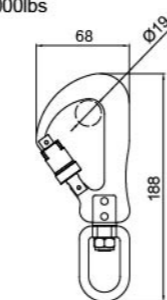

Aluminum Carabiner



D Carabiner
CBRAD-ALF-001

Min. Breaking Strength: 23kN/5000lbs
Forged Aluminum Alloy
Twist Lock
Anodized

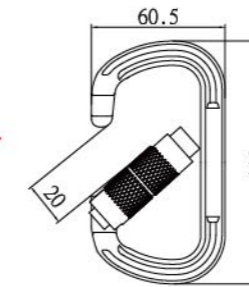

D Carabiner
CBRAD-ALF-002

Min. Breaking Strength: 23kN/5000lbs
Forged Aluminum Alloy
Twist Lock
Anodized

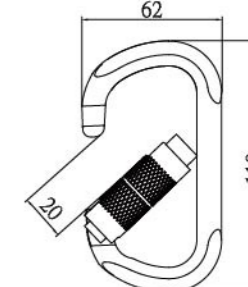

D Carabiner
CBRD-AL11-001

Min. Breaking Strength: 23kN/5000lbs
Aluminum Alloy
Screw Lock
Anodized

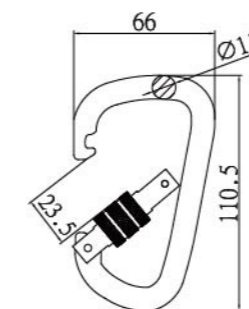

D1 Carabiner
CBRAD1-ALF-001

Min. Breaking Strength: 23kN/5000lbs
Forged Aluminum Alloy
Twist Lock
Anodized

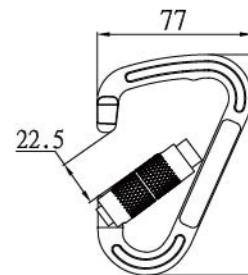

D1 Carabiner
CBRAD1-ALF-002

Min. Breaking Strength: 23kN/5000lbs
Forged Aluminum Alloy
Twist Lock
Anodized

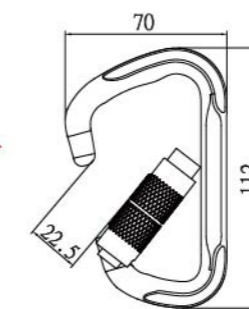

D1 Carabiner
CBRAD1-ALF-003

Min. Breaking Strength: 23kN/5000lbs
Forged Aluminum Alloy
Twist Lock
Anodized

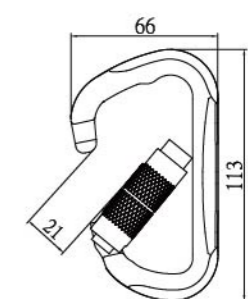

Aluminum Carabiner



D1 Carabiner
CBRAD1-ALF-004

Min. Breaking Strength: 23kN/5000lbs
Forged Aluminum Alloy
Twist Lock
Anodized

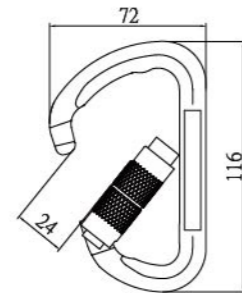

WAIST Carabiner
SH01AX-ALF-001

Min. Breaking Strength: 23kN/5000lbs
Forged Aluminum Alloy
Twist Lock
Anodized

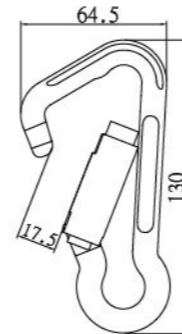

Carabiner
CBRAD-AL08-001

Min. Breaking Strength: 9kN/2000lbs
Aluminum Alloy
With Captive Pin
Twist Lock
Anodized

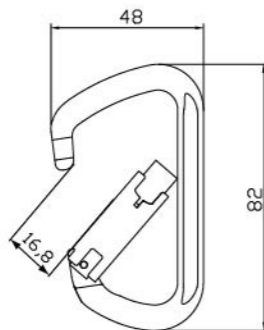

Quick Connector
LQ02-AL08-001

Min. Breaking Strength: 9kN/2000lbs
Aluminum Alloy
Quick Lock
Anodized

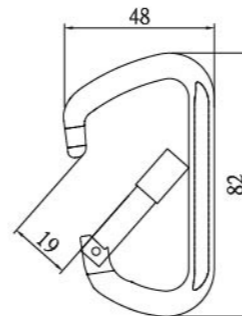

Swivel Connector
CBRADV-ALF-001

Min. Breaking Strength: 9kN/2000lbs
Forged Aluminum Alloy
Twist Lock
Anodized

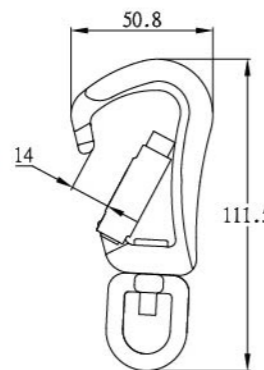

Fall Protection For Tools

Tool Set with Bungee Rope makes work environments safer and more productive by drastically reducing falling object incidents resulting in personal injury, equipment damage, and tool loss.



Tool Set with Bungee Rope

TOOL SET-01

Aluminum Swivel Connectors
Twist Lock
Anodized
Bungee Rope 52cm, extended 104cm



Snap Hook



Self Locking Rebar Hook

RBH-001

Min. Breaking Strength: 23kN/5000lbs
Alloy Steel

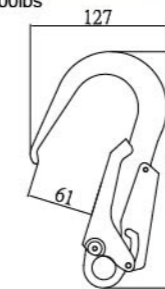

Aluminum Rebar Hook

RBH-L-AL-002

Min. Breaking Strength: 23kN/5000lbs
Forged Aluminum Alloy

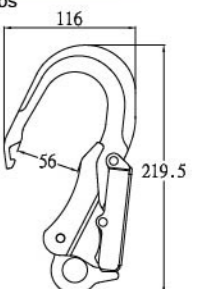

Self Locking Rebar Hook

RBH-003

Min. Breaking Strength: 23kN/5000lbs
Forged Alloy Steel

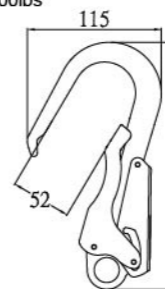

Self Locking Rebar Hook

RBH-003-1

Min. Breaking Strength: 23kN/5000lbs
Forged Alloy Steel
Electric Color Plated

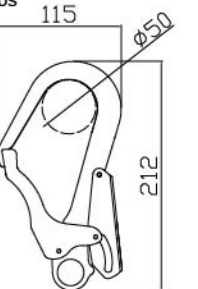

Snap Hook



Stamped Rebar Hook
RBH-004

Min. Breaking Strength: 23kN/5000lbs
Alloy Steel
Kwiklock

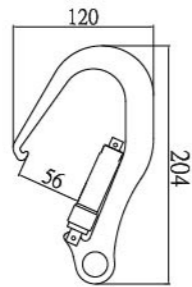

Eyelet Rebar Hook
RBH-005

Min. Breaking Strength: 23kN/5000lbs
Alloy Steel
Twist Lock

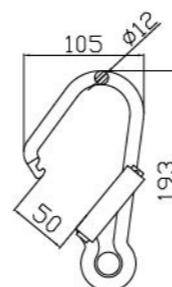

Self Locking Snap Hook
RBH-M-001

Min. Breaking Strength: 23kN/5000lbs
Alloy Steel

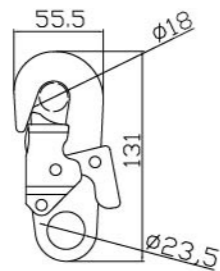

Self Locking Snap Hook
RBH-S-001

Min. Breaking Strength: 23kN/5000lbs
Alloy Steel

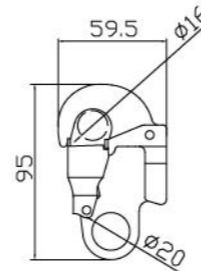

Self Locking Snap Hook
RBH-M-002

Min. Breaking Strength: 23kN/5000lbs
Alloy Steel
Auto Lock

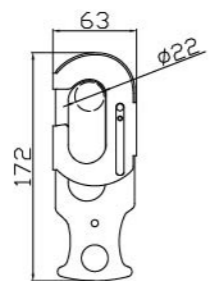

Self Locking Snap Hook
RBH-M-AL-001

Min. Breaking Strength: 23kN/5000lbs
Forged Aluminum Alloy
Twist Lock

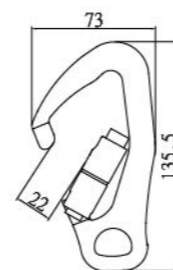

Screw Locking Snap Hook
RBH-M-AL-002

Min. Breaking Strength: 23kN/5000lbs
Forged Aluminum Alloy
Screw Lock
Anodized Titanium

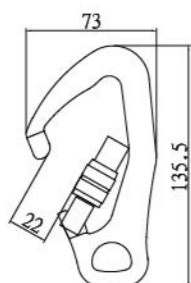

Safety Buckle



Harness Safety Buckle
Supplied with various material on the body, bolt and buckle, hooks
for varying harness configurations.



Harness Safety Buckle
HSB-001AL-GG

Min. Breaking Strength: 12kN/2500lbs
Aluminum Alloy
Safety Locking System
Webbing: 1 3/4" (45mm)
Net Weight: 75g



Harness Safety Buckle
HSB-001H1

Min. Breaking Strength: 15kN/3000lbs
Alloy Steel
Safety Locking System
Webbing: 1 3/4" (45mm)
Net Weight: 120g



Harness Safety Buckle
HSB-001SP-1

Min. Breaking Strength: 10kN/2000lbs
SUS 304/SUS 316
Safety Locking System
Webbing: 1 3/4" (45mm)
Net Weight: 149 gm

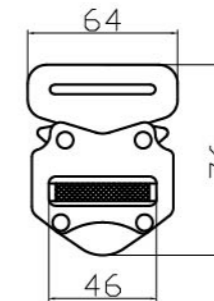

Swivel Connector



Swivel Connector
SWC-01

Min. Breaking Strength: 40kN/8900lbs
Forged Alloy Steel



Stainless Swivel Connector
SWC-02

Min. Breaking Strength: 35kN/7500lbs
SUS 304/SUS 316



Aluminum Swivel Connector
SWC-03

Min. Breaking Strength: 9kN/2000lbs
Forged Aluminum Alloy
Anodized Silver



Aluminum Swivel Connector
SWC-04

Min. Breaking Strength: 9kN/2000lbs
Forged Aluminum Alloy
Anodized Gold



Aluminum Swivel Connector
SWC-05

Min. Breaking Strength: 9kN/2000lbs
Forged Aluminum Alloy
Anodized Pink

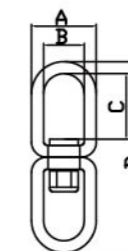

Item No.	A mm	B mm	C mm	D mm
SWC-01/02	43	27	43.5	127
SWC-03/04/05	29.4	17	19.5	69.4