

# LM series



Linear Motor

\* cpc reserves the right to revise any information(technical details) any time without notice, for printing mistakes or any other incidental mistakes. We take no responsibility.



## *Contents*

Parameter Glossary.....	P01-P02
Continuous Force & Ordering Information.....	P03-P04

### LM-Ironless series

Construction & Features .....	P05-P08
LM PM Assembly Specifications and Dimensions.....	P09-P10
LM PA Assembly Specifications and Dimensions.....	P11-P12
LM PAX Assembly Specifications and Dimensions.....	P13-P14
LM PB Assembly Specifications and Dimensions.....	P15-P16
LM PBX Assembly Specifications and Dimensions.....	P17-P18
LM PD Assembly Specifications and Dimensions.....	P19-P20
LM PDX Assembly Specifications and Dimensions.....	P21-P22
LM PDL Assembly Specifications and Dimensions.....	P23-P24
LM PEX Assembly Specifications and Dimensions.....	P25-P26

### LM-Ironcore series

Product Features.....	P27-P28
CA-55 Assembly Specifications and Dimensions.....	P29-P30
CA-75 Assembly Specifications and Dimensions.....	P31-P32
CA-115 Assembly Specifications and Dimensions.....	P33-P34
CB-60 Assembly Specifications and Dimensions.....	P35-P36
CB-80 Assembly Specifications and Dimensions.....	P37-P38
CB-120 Assembly Specifications and Dimensions.....	P39-P40
CC-64 Assembly Specifications and Dimensions.....	P41-P42
CC-84 Assembly Specifications and Dimensions.....	P43-P44
CC-124 Assembly Specifications and Dimensions.....	P45-P46

### Selection Application Table

Selection Example.....	P47-48
Selection Application Table.....	P49-54

## Parameter Glossary

### Lp (mm) Coil Assembly Length

The coil assembly's aluminum base length. The cable bending radius is not counted toward this length. A linear motor's effective stroke is usually the magnetic way length minus the coil length and cable bending radius.

### Pm (Kg) Coil Assembly Weight

Includes main body and 40 mm cable length weight. This mass needs to be factored into the motor load during actual use.

### Ic (Apk) Continuous Current

Under an ambient condition of 25 °C and even cycling between the 3 currents, the peak line temperature level will be no higher than 110 degrees celsius. Generally speaking, continuous current will vary with alternate motor motion profiles, connection component sizes and the surrounding environment. E.g: mover current tolerance capacity under vacuum conditions is significantly less than under nominal air pressure; stationary movers can tolerate lower levels of continuous current than when in motion; movers not connected to additional machinery can only tolerate lower continuous current. The electricity current measurements provided in this catalogue are of peak values.

Unit conversion :

$$A_{peak} = \sqrt{2} \times A_{rms}$$

$$\text{Line current}(Y) = \sqrt{3} \times \text{Phase current}(Y)$$

-----Y connection

$$\text{Line current}(\Delta) = \sqrt{3} \times \text{Phase current}(\Delta)$$

-----Δconnection

### Sm (Kg/m) Magnetic Way Weight

Nominal weight of the magnetic way per meter length.

### Ip (Apk) Peak Current

Instantaneous maximum force that can be produced by the motor. To prevent irreversible damage, duration should be less than 1 second and a duty cycle of under 4%.

### Fp (N) Peak Force

Maximum force that can be produced by the motor. To prevent irreversible damage, motion duration should be less than 1 second at a duty cycle of under 4%.

### Fc (N) Continuous Force

With its long term continuous force, the motor coil will at most reach a maximum temperature of 110°C.

### Ke (V·s/m/s) Back EMF constant

The peak line-to-line counter EMF produced at a one meter/second motor velocity.

Maximum voltage required by a motor in motion is:

$$\text{Volt} = (K_e \times V_{max}) + (I_{max} \times R)$$

It is recommended that the driver's maximum deliverable voltage is at least 1.3 times greater than the maximum voltage required to ensure that there is enough current to power the motor.

Unit conversion :

$$V_{peak} = \sqrt{2} \times V_{rms}$$

$$\text{Line voltage}(Y) = \sqrt{3} \times \text{Phase voltage}(Y)$$

----- Y connection

$$\text{Line voltage}(\Delta) = \sqrt{3} \times \text{Phase voltage}(\Delta)$$

-----Δconnection

### Kf (N/Apk) Force Constant

The thrust force produced by the motor per unit amp of current. The **cpc** catalog measures this at peak values.

$$I_{peak} = \sqrt{2} \times I_{rms}$$

### τ<sub>e</sub> (ms) Time Constant

Time needed to reach 63% of the current target level. This can be discerned via electric inductance and resistance. Generally, ironless linear motors have a smaller time constant than ironcore linear motors and thus also have a faster response rate.

### K<sub>w</sub> (N/√W) Motor Constant

A measure of motor efficiency, a higher motor constant indicates that for the same power input, greater force is produced.

### τ<sub>p</sub> (mm) Pole Pitch

The distance between identical magnetic poles within the stator, i.e. S-S or N-N, This is equivalent to the commutation cycle length.

### R (Ω) Resistance

Motor coil three phase Line-to-Line resistance. Connecting the coils in parallel reduces the constant and Inductance, but proportionally increases the amount of current required to achieve the same level of thrust. For copper coils, there is a 0.393% increase in resistance for every 1°C rise in temperature.

### L (mH) Inductance

Motor three phase Line-to-Line inductance. The lower inductance levels demonstrate that the motor's electrical loop response is faster.

### R<sub>th</sub> (°C/W) Thermal Resistance

Heat rise of the coil per unit watt of power input. Generally, the smaller the thermal resistance the better the heat dissipation structure.



### Continuous Force Overview

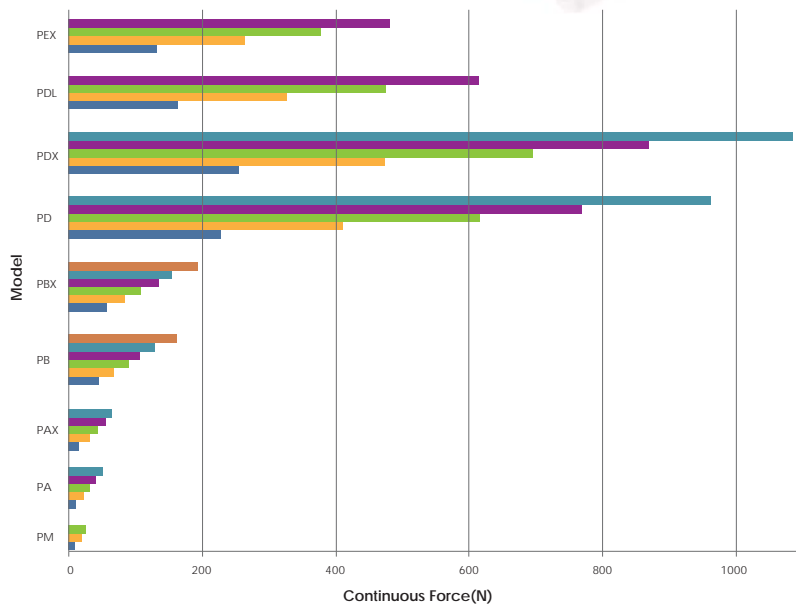

### Continuous Force Overview

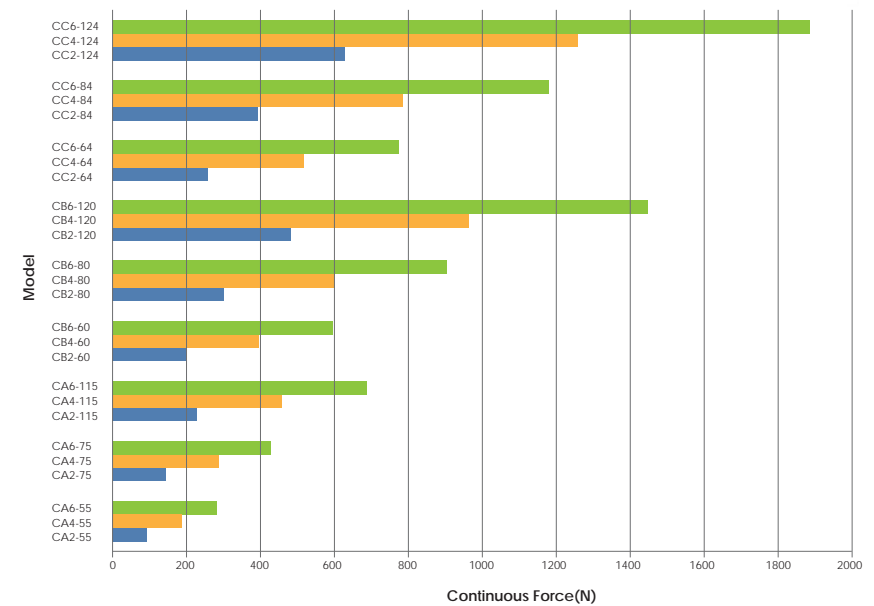

### Ordering Information

#### Coil Assembly

LM	PA	1	W1	N	NC	400
Cable Length in mm (400mm Standard)						
Cooling NC - no cooling AC - air cooling						
Halls N - no hall sensor H - with hall sensor						
Winding Type W1-winding 1 W3-winding 3 W2-winding 2 W4-winding 4						
Coil assembly count PM Type : 2.4.6 PD Type : 2.4.6.8.10 PA Type : 1.2.3.4.5 PD-X Type : 2.4.6.8.10 PA-X Type : 1.2.3.4.5 PDL Type : 2.4.6.8 PB Type : 2.3.4.5.6.8 PE-X Type : 2.4.6.8 PB-X Type : 2.3.4.5.6.8						
Coil Assembly PM series PA series PA-X series PB series PE-X series PB-X series PD series PD-X series PDL series						
Linear Motor						

#### Magnetic Way

LM	SA	0
Magnetic Way Length 0 - 120mm 1 - 300mm 2 - 480mm		
Magnetic Way SM series SA series SA-X series SB series SB-X series SD series SD-X series SDL series SE-X series		
Linear Motor		

### Ordering Information

#### Coil Assembly

LM	CA	2	75	S	H	NC	400
Cable Length in mm (400mm Standard)							
Cooling NC - no cooling WC - water cooling							
Halls N - no hall sensor H - with hall sensor							
Winding Type S,S,P,P,D							
Assembly width CC-64,84,124 CA-55,75,115 CB-60,80,120							
Winding Quantity 2 - 2 coils 4 - 4 coils 6 - 6 coils							
Coil Assembly CA series CB series CC series							
Linear Motor							

#### Magnetic Way

LM	MA	0	75	N
Magnet Protection 1. N - None 2. S - Stainless Steel 3. E - Epoxy				
Assembly width CC-64,84,124 CA-55,75,115 CB-60,80,120				
Magnetic Way Length 0-MA : 120 MB : 120 MC : 114 1-MA : 360 MB : 300 MC : 304 2-MA : 480 MB : 480 MC : 456				
Magnetic Way MA series MB series MC series				
Linear Motor				

CPC also provides servo drives, optical linear scales and magnetic linear scales. For more details, please contact [cpc](mailto:cpc).



Ironless Linear Motor Series  
PAT.

## Ironless Linear Motors

### Construction & Features

Provides fast acceleration with zero cogging for high velocities, super-smooth motion and superior position control.

#### Construction

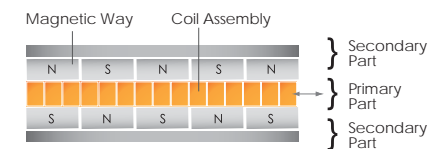

- **cpc** linear motors are composed of two pieces: a Coil Assembly (forcer) and a stationary Magnetic Way (Stator).
- The Coil Assembly is an ironless design, with the coils placed in a precisely molded resin shell.
- The Magnetic Way consists of two parallel steel plates with embedded rare-earth magnets facing each other. The two plates are joined at one end to create space for the Coil Assemblies to run.

#### Ironless advantages

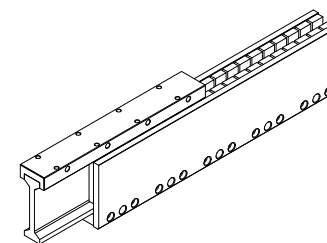

- **Magnetic Forces Contained**  
Magnetic Way consists of a balanced dual-magnet track, so there are no magnetic forces to deal with during assembly.
- **No Cogging**  
Ironless Coil Assembly results in zero cogging and super-smooth motion.
- **Low Weight Forcer**  
Absence of iron results in higher acceleration and deceleration rates as well as a higher mechanical bandwidth.
- **Wide Air Gap**  
Large air gap allows easy installation and alignment.

#### cpc Features

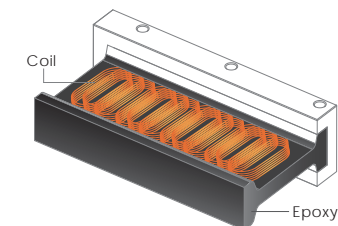

- **cpc** linear motors are designed with overlapping coils to provide very high force density.
- **cpc** uses a vacuum-molding process to eliminate air bubbles from the finished epoxy mold. This results in a strengthened epoxy product with an enhanced lifetime.
- **cpc** linear motors are designed to have great dielectric strength, resulting in highly stable systems.
- **cpc** linear motors are very efficient at dissipating waste heat, allowing handling of larger currents for increased power.
- **cpc** motor parameters, force constant refers to the amount of force produced per one ampere of current, while motor constant is the force produced per Watt and is representative of the motor's efficiency. As such the motor constant is a better metric at evaluating motor performance. **cpc**'s linear motors have been designed with the aid of advanced simulation software. As a result, for a given dimension **cpc** motors have a higher motor constant.

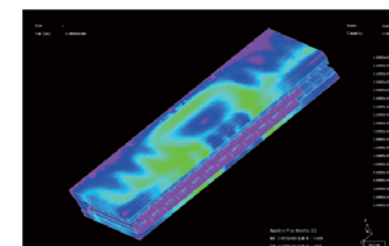

## Linear Motor Thermal Analysis

In a linear motor system, the slider, linear guide and base are all paths of heat dissipation for the coil. Similarly, cooling effects are also achieved by the natural air flow over the motor while it is in motion. The thermograph image on the right shows the overall linear motor system temperature distribution after reaching thermal equilibrium. It is obvious from this that the heat from the coil is dissipated through everything it is in contact with. To ease estimation of the required heat sinking capacity, the cpc catalog provides separate continuous current values. One value assumes that the motor is without a heat sink and a second that it is equipped with a nominally sized heat sink. Both conditions assume an even three phase current distribution.

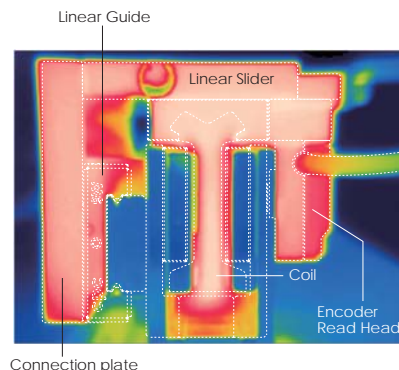

## Stationary Measurements

The figure below shows the test setup method from which the "without heat sink" continuous current value is derived. The coil is placed on thermally insulating material at 25°C and 1 atmospheric pressure. An evenly cycled three phase current is then injected into the coils, ensuring that the average heat level does not surpass 110°C.

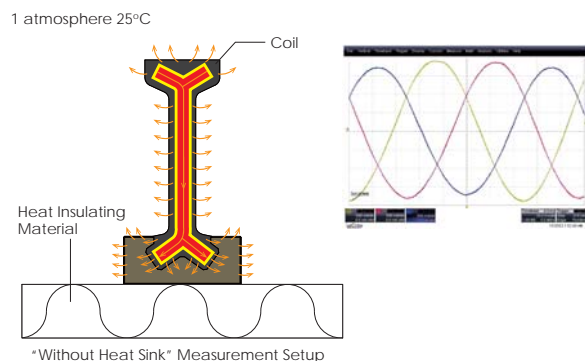

The figure below shows the test setup method from which the "with heat sink" continuous current value has been derived. The coil is covered with thermal grease and placed on an aluminum plate at 25°C and 1 atmospheric pressure. An evenly cycled three phase current is then conducted into the coils, ensuring that the average heat level does not surpass 110°C.

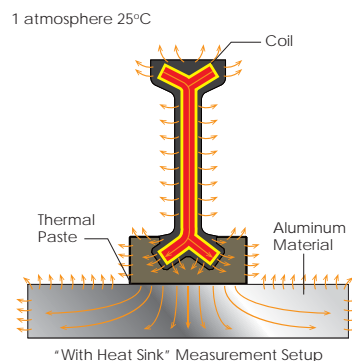

## Dynamic System Measurement

Motion profile: Point to Point continuous back and forth movement

Travel: 150mm

Continuous Current : 3.4A

Slider Material: Aluminum (130x125x8mm)

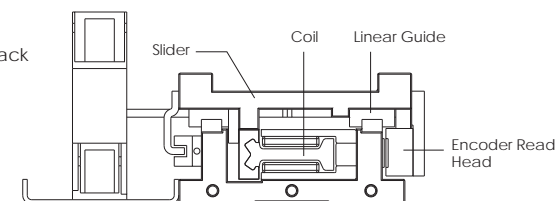

The measurement shows that despite consuming the same amount of heat, a fast moving motor coil under a similar design structure comes under a stronger thermal convection and attains a lower thermal equilibrium temperature.

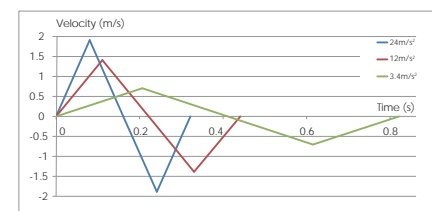

Motion profile under different accelerations that utilize the same continuous current.

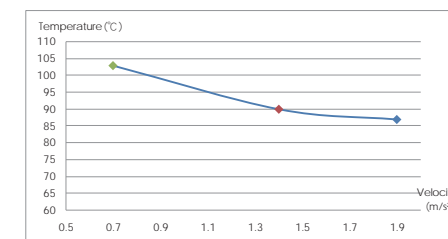

Equilibrium temperature reached under varying maximum velocities for the same continuous current.

## Suggestion

Unlike conventional rotary motors, linear motors are mechanically open systems due to the way external components are connected. Hence, the continuous force that the motor can achieve is highly dependent on its heat dissipation structure, in motion thermal convection rates and other external factors. For example, at one particle elevation above sea level, ambient air pressure measures as follows:

$$P_h = 760 - (h/12.5)$$

$P_h$  : Atmospheric pressure(torr)

$h$  : Elevation above sea level (m)

As atmospheric pressure decreases with elevation, air density decreases while the convection cooling effect will be reduced as well. As a general guide, the achievable continuous force under vacuum conditions is 50% of that under atmospheric conditions. **cpc** suggests that for most application purposes, the "with heat sink" value be used as the main metric in motor sizing selection. Should the "without heat sink" value be used instead, this could easily lead to problems of over design.

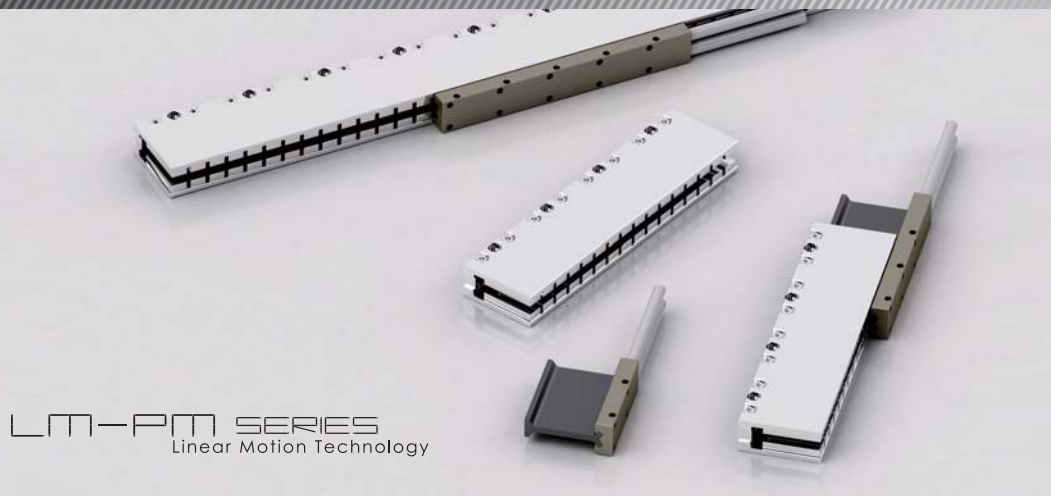

## LM-PM SERIES Linear Motion Technology

### LM-PM Coil Assembly Model

Coil Assembly Model	LM-PM2			LM-PM4			LM-PM6		
Winding code	W1	W2	W3	W1	W2	W3	W1	W2	W3
<b>Performance<sup>(1)</sup></b>									
Peak force with heat sink(N) <sup>(1)(2)</sup>	37.0			74.0			102.1		
Peak force without heat sink(N) <sup>(2)(3)</sup>	26.6			53.3			71.0		
Continuous force with heat sink(N) <sup>(1)(2)</sup>	9.2			18.5			25.5		
Continuous force without heat sink(N) <sup>(2)(3)</sup>	6.7			13.3			17.8		
Peak power(W) <sup>(1)(2)</sup>	230.0			460.0			584.0		
Continuous power(W) <sup>(1)(2)</sup>	14.4			28.8			36.5		
<b>Mechanical</b>									
Coil assembly length(mm)	40			70			100		
Coil assembly weight(kg) <sup>(2)</sup>	0.04			0.07			0.10		
Magnetic way weight(kg/m) <sup>(2)</sup>	2.0			2.0			2.0		
Pole pitch(mm)	15			15			15		
<b>Electrical<sup>(4)</sup></b>									
Continuous current with heat sink(A <sub>pk</sub> ) <sup>(2)(3)</sup>	2.5	5	10	2.5	5	10	2.3	4.6	9.2
Continuous current without heat sink(A <sub>pk</sub> ) <sup>(2)(3)</sup>	1.8	3.6	7.2	1.8	3.6	7.2	1.6	3.2	6.4
Peak current with heat sink(A <sub>pk</sub> ) <sup>(1)(2)</sup>	10	20	40	10	20	40	9.2	18.4	36.8
Peak current without heat sink(A <sub>pk</sub> ) <sup>(2)(3)</sup>	7.2	14.4	28.8	7.2	14.4	28.8	6.4	12.8	25.6
Force constant(N/A <sub>pk</sub> ) <sup>(2)</sup>	3.7	1.8	0.9	7.4	3.7	1.8	11.1	5.5	2.8
Back EMF constant(V <sub>pk(0.1)</sub> / m/s) <sup>(2)</sup>	4.3	2.2	1.1	8.6	4.3	2.2	12.9	6.5	3.2
Resistant(Ohms) <sup>(2)</sup>	2.3	0.6	0.1	4.6	1.2	0.3	6.9	1.7	0.4
Inductance(mH) <sup>(2)</sup>	0.09	0.02	0.01	0.18	0.04	0.01	0.3	0.07	0.02
Time constant(ms) <sup>(2)</sup>	0.04	0.04	0.04	0.04	0.04	0.04	0.04	0.04	0.04
Thermal resistant with heat sink(°C/W) <sup>(1)(2)</sup>	4.6			2.3			1.8		
Thermal resistant without heat sink(°C/W) <sup>(2)(3)</sup>	8.8			4.4			3.8		
Heat sink(mm)	300x200x12			300x200x12			300x200x12		
Motor constant(N/√W) <sup>(2)</sup>	2.4			3.4			4.2		
Ph-PE dielectric strength <sup>(2)</sup>	≥ 5KV(AC)			≥ 5KV(AC)			≥ 5KV(AC)		
Ph-PE insulation resistance <sup>(2)</sup>	≥ 1KV(DC)			≥ 1KV(DC)			≥ 1KV(DC)		

- (1) Value applies to the static sinusoidal drive, under specific heat sink and temperatures from 25°C to 110°C. Actual performance depends on heat sink configuration, system cooling conditions and the ambient temperature.
- (2) The tolerance of all performance and electrical specification is ±10%.
- (3) The value applies to the static sinusoidal drive at temperatures from 25°C up to 110°C, without heat sink.
- (4) The above "without heat sink" figure assumes a working condition of 1atm at a 25°C ambient temperature, with the stationary linear motor not in contact with any other objects, relying only on air convection for cooling. As all heat conductive objects in direct contact with the linear motor, including the sliding plate, linear guide, and base, can be considered a type of heat sink, the "with heat sink" figure should be taken as the primary reference for actual application design.

### LM-PM Coil Assembly

	Np1	Np2	Lp	Mp	A	B	C	D
LM-PM2	1	1	40	35	3	6.5	17	13.5
LM-PM4	2	2	70	65	13	16.5	17	13.5
LM-PM6	4	4	100	95	3	6.5	17	13.5

### LM-SM Magnetic Way

	Ns	Ls
LM-SM0	3	120
LM-SM1	9	300
LM-SM2	15	480

### LM-PM Coil Assembly

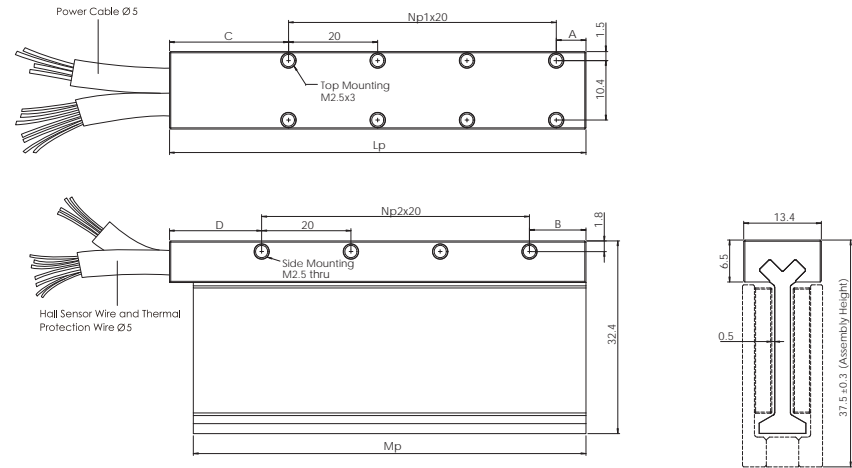

### LM-SM Magnetic Way

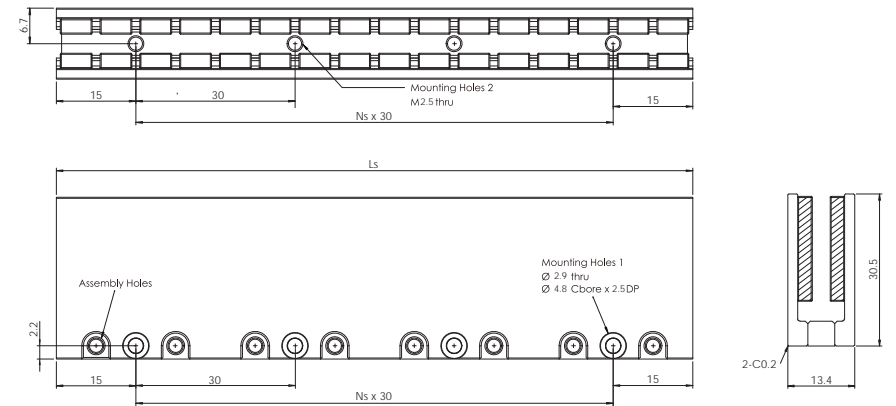

OUTPUT CABLE ( All cable standard length is 400 mm)

Motor Wire Table			Hall Sensor Wire Table and Thermal Protection Wire Table					
Pin Number	Function	Cross section	Color	Function	Cable Dia.	Color	Function	Cable Dia.
White	U phase	0.25 mm <sup>2</sup>	Pink	Hall A U phase	0.14 mm <sup>2</sup>	Brown	Thermal sensor	0.14 mm <sup>2</sup>
Yellow	V phase	0.25 mm <sup>2</sup>	Yellow	Hall B V phase	0.14 mm <sup>2</sup>	Blue	Shielding	
Brown	W phase	0.25 mm <sup>2</sup>	Green	Hall C W phase	0.14 mm <sup>2</sup>			
Green	PE - shielding	0.25 mm <sup>2</sup>	Grey	Hall IC - 5V	0.14 mm <sup>2</sup>			
			White	GND	0.14 mm <sup>2</sup>			

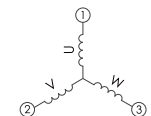



LM-PA SERIES  
Linear Motion Technology

### LM-PA Coil Assembly Model

Coil Assembly Model	LM-PA1		LM-PA2		LM-PA3		LM-PA4			LM-PA5	
Winding code	W1	W1	W2	W1	W2	W1	W2	W3	W1	W2	
<b>Performance<sup>(1)</sup></b>											
Peak force with heat sink(N) <sup>(1)(2)</sup>	47.7	90.4		128.1		160.7			200.9		
Peak force without heat sink(N) <sup>(2)(3)</sup>	30.1	60.3		90.4		110.5			138.1		
Continuous force with heat sink(N) <sup>(1)(2)</sup>	11.9	22.6		32		40.2			50.2		
Continuous force without heat sink(N) <sup>(2)(3)</sup>	7.5	15.1		22.6		27.6			34.5		
Peak power(W) <sup>(1)(2)</sup>	421.6	756.9		1012.7		1196			1495		
Continuous power(W) <sup>(1)(2)</sup>	26.4	47.3		63.3		74.8			93.4		
<b>Mechanical</b>											
Coil assembly length(mm)	50	80		110		140			170		
Coil assembly weight(kg) <sup>(2)</sup>	0.08	0.12		0.16		0.20			0.24		
Magnetic way weight(kg/m) <sup>(2)</sup>	4.4	4.4		4.4		4.4			4.4		
Pole pitch(mm)	30	30		30		30			30		
<b>Electrical<sup>(4)</sup></b>											
Continuous current with heat sink(A <sub>pk</sub> ) <sup>(2)(3)</sup>	1.9	1.8	3.6	1.7	3.4	1.6	3.2	6.4	1.6	3.2	
Continuous current without heat sink(A <sub>pk</sub> ) <sup>(2)(3)</sup>	1.2	1.2	2.4	1.2	2.4	1.1	2.2	4.4	1.1	2.2	
Peak current with heat sink(A <sub>pk</sub> ) <sup>(1)(2)</sup>	7.6	7.2	14.4	6.8	13.6	6.4	12.8	25.6	6.4	12.8	
Peak current without heat sink(A <sub>pk</sub> ) <sup>(2)(3)</sup>	4.8	4.8	9.6	4.8	9.6	4.4	8.8	17.6	4.4	8.8	
Force constant(N/A <sub>pk</sub> ) <sup>(2)</sup>	6.3	12.6	6.3	18.8	9.4	25.1	12.6	6.3	31.4	15.7	
Back EMF constant(V <sub>pk(0-0)</sub> / m/s) <sup>(2)</sup>	7.3	14.6	7.3	21.9	11	29.2	14.6	7.3	36.5	18.3	
Resistant(Ohms) <sup>(2)</sup>	7.3	14.6	3.7	21.9	5.5	29.2	7.3	1.8	36.5	9.1	
Inductance(mH) <sup>(2)</sup>	1.25	2.5	0.63	3.75	0.94	5	1.25	0.13	6.25	1.56	
Time constant(ms) <sup>(2)</sup>	0.17	0.17	0.17	0.17	0.17	0.17	0.17	0.17	0.17	0.17	
Thermal resistant with heat sink(°C/W) <sup>(1)(2)</sup>	2.7	1.6		1.3		1			0.7		
Thermal resistant without heat sink(°C/W) <sup>(2)(3)</sup>	6.8	3.9		2.7		2.2			1.7		
Heat sink(mm)	250x250x25	250x250x25		250x250x25		250x250x25			250x250x25		
Motor constant(N/√W) <sup>(2)</sup>	2.3	3.3		4.0		4.6			5.2		
Ph-PE dielectric strength <sup>(2)</sup>	≥ 5KV(AC)	≥ 5KV(AC)		≥ 5KV(AC)		≥ 5KV(AC)			≥ 5KV(AC)		
Ph-PE insulation resistance <sup>(2)</sup>	≥ 1KV(DC)	≥ 1KV(DC)		≥ 1KV(DC)		≥ 1KV(DC)			≥ 1KV(DC)		

- (1) Value applies to the static sinusoidal drive, under specific heat sink and temperatures from 25°C to 110°C. Actual performance depends on heat sink configuration, system cooling conditions and the ambient temperature.
- (2) The tolerance of all performance and electrical specification is ±10%.
- (3) The value applies to the static sinusoidal drive at temperatures from 25°C up to 110°C, without heat sink.
- (4) The above "without heat sink" figure assumes a working condition of 1atm at a 25°C ambient temperature, with the stationary linear motor not in contact with any other objects, relying only on air convection for cooling. As all heat conductive objects in direct contact with the linear motor, including the sliding plate, linear guide, and base, can be considered a type of heat sink, the "with heat sink" figure should be taken as the primary reference for actual application design.

### LM-PA Coil Assembly

	Np1	Np2	Lp	Mp	A	B	C	D
LM-PA1	1	1	50	44	10	5	15	20
LM-PA2	2	2	80	74	15	10	15	20
LM-PA3	3	3	110	104	20	15	15	20
LM-PA4	4	4	140	134	25	20	15	20
LM-PA5	6	5	170	164	5	25	15	20

### LM-SA Magnetic Way

	Ns	Ls
LM-SA0	1	120
LM-SA1	4	300
LM-SA2	7	480

### LM-PA Coil Assembly

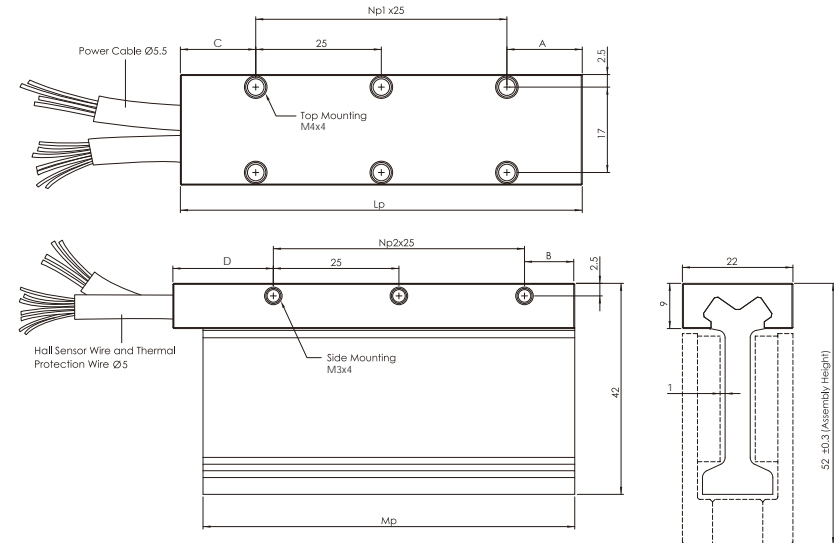

### LM-SA Magnetic Way

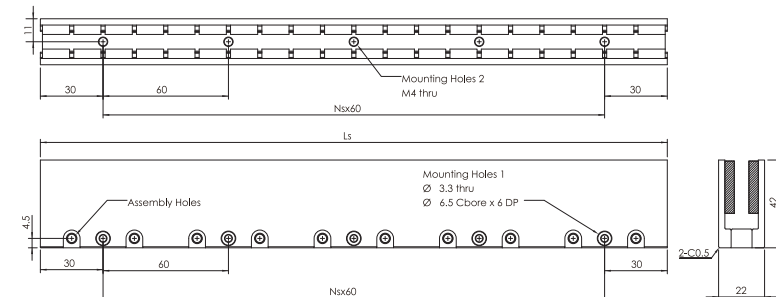

### OUTPUT CABLE (All cable standard length is 400 mm)

Motor Wire Table			Hall Sensor Wire Table and Thermal Protection Wire Table					
Pin Number	Function	Cross section	Color	Function	Cable Dia.	Color	Function	Cable Dia.
White	U phase	0.25 mm <sup>2</sup>	Pink	Hall A U phase	0.14 mm <sup>2</sup>	Brown	Thermal sensor	0.14 mm <sup>2</sup>
Yellow	V phase	0.25 mm <sup>2</sup>	Yellow	Hall B V phase	0.14 mm <sup>2</sup>	Blue	Shielding	
Brown	W phase	0.25 mm <sup>2</sup>	Green	Hall C W phase	0.14 mm <sup>2</sup>			
Green	PE + shielding	0.25 mm <sup>2</sup>	Grey	Hall IC + 5V	0.14 mm <sup>2</sup>			
			White	GND	0.14 mm <sup>2</sup>			

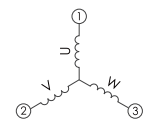



## LM-PA-X SERIES

Linear Motion Technology

### LM-PA-X Coil Assembly Model

Coil Assembly Model	LM-PA-X1		LM-PA-X2		LM-PA-X3		LM-PA-X4			LM-PA-X5	
Winding code	W1	W1	W2	W1	W2	W1	W2	W3	W1	W2	
<b>Performance<sup>(1)</sup></b>											
Peak force with heat sink(N) <sup>(1)(2)</sup>	65.4	123.8	175.4	220.2	258						
Peak force without heat sink(N) <sup>(2)(3)</sup>	44.7	82.6	113.5	151.4	189.2						
Continuous force with heat sink(N) <sup>(1)(2)</sup>	16.3	31	43.9	55	64.5						
Continuous force without heat sink(N) <sup>(2)(3)</sup>	11.2	20.6	28.4	37.8	47.3						
Peak power(W) <sup>(1)(2)</sup>	491	881.3	1179.1	1392.6	1537.2						
Continuous power(W) <sup>(1)(2)</sup>	30.7	55.1	73.7	87	96.1						
<b>Mechanical</b>											
Coil assembly length(mm)	50	80	110	140	170						
Coil assembly weight(kg) <sup>(2)</sup>	0.08	0.13	0.18	0.23	0.28						
Magnetic way weight(kg/m) <sup>(2)</sup>	4.4	4.4	4.4	4.4	4.4						
Pole pitch(mm)	30	30	30	30	30						
<b>Electrical<sup>(4)</sup></b>											
Continuous current with heat sink(A <sub>pk</sub> ) <sup>(2)(3)</sup>	1.9	1.8	3.6	1.7	3.4	1.6	3.2	6.4	1.5	3	
Continuous current without heat sink(A <sub>pk</sub> ) <sup>(2)(3)</sup>	1.3	1.2	2.4	1.1	2.2	1.1	2.2	4.4	1.1	2.2	
Peak current with heat sink(A <sub>pk</sub> ) <sup>(1)(2)</sup>	7.6	7.2	14.4	6.8	13.6	6.4	12.8	25.6	6	12	
Peak current without heat sink(A <sub>pk</sub> ) <sup>(2)(3)</sup>	5.2	4.8	9.6	4.4	8.8	4.4	8.8	17.6	4.4	8.8	
Force constant(N/A <sub>pk</sub> ) <sup>(2)</sup>	8.6	17.2	8.6	25.8	12.9	34.4	17.2	8.6	43	21.5	
Back EMF constant(V <sub>pk(0-0)}</sub> / m/s) <sup>(2)</sup>	10	20	10	30	15	40	20	10	50	25	
Resistant(Ohms) <sup>(2)</sup>	8.5	17	4.3	25.5	6.4	34	8.5	2.1	42.7	10.7	
Inductance(mH) <sup>(2)</sup>	1.65	3.3	0.83	4.95	1.24	6.6	1.65	0.41	8.27	2.07	
Time constant(ms) <sup>(2)</sup>	0.19	0.19	0.19	0.19	0.19	0.19	0.19	0.19	0.19	0.19	
Thermal resistant with heat sink(°C/W) <sup>(1)(2)</sup>	2.5	1.5		1.1		0.9			0.7		
Thermal resistant without heat sink(°C/W) <sup>(2)(3)</sup>	4.9	3.5		2.7		2			1.6		
Heat sink(mm)	250x250x25	250x250x25	250x250x25	250x250x25	250x250x25	250x250x25	250x250x25	250x250x25	250x250x25	250x250x25	
Motor constant(N/√W) <sup>(2)</sup>	2.9	4.2		5.1		5.9			6.6		
Ph-PE dielectric strength <sup>(2)</sup>	≥ 5KV(AC)	≥ 5KV(AC)	≥ 5KV(AC)	≥ 5KV(AC)	≥ 5KV(AC)	≥ 5KV(AC)	≥ 5KV(AC)	≥ 5KV(AC)	≥ 5KV(AC)	≥ 5KV(AC)	
Ph-PE insulation resistance <sup>(2)</sup>	≥ 1KV(DC)	≥ 1KV(DC)	≥ 1KV(DC)	≥ 1KV(DC)	≥ 1KV(DC)	≥ 1KV(DC)	≥ 1KV(DC)	≥ 1KV(DC)	≥ 1KV(DC)	≥ 1KV(DC)	

(1) Value applies to the static sinusoidal drive, under specific heat sink and temperatures from 25°C to 110°C. Actual performance depends on heat sink configuration, system cooling conditions and the ambient temperature.

(2) The tolerance of all performance and electrical specification is ±10%.

(3) The value applies to the static sinusoidal drive at temperatures from 25°C up to 110°C, without heat sink.

(4) The above "without heat sink" figure assumes a working condition of 1atm at a 25°C ambient temperature, with the stationary linear motor not in contact with any other objects, relying only on air convection for cooling. As all heat conductive objects in direct contact with the linear motor, including the sliding plate, linear guide, and base, can be considered a type of heat sink, the "with heat sink" figure should be taken as the primary reference for actual application design.

### LM-PA-X Coil Assembly

	Np1	Np2	Lp	Mp	A	B	C	D
LM-PA-X1	1	1	50	44	10	5	15	20
LM-PA-X2	2	2	80	74	15	10	15	20
LM-PA-X3	3	3	110	104	20	15	15	20
LM-PA-X4	4	4	140	134	25	20	15	20
LM-PA-X5	6	5	170	164	5	25	15	20

### LM-SA-X Magnetic Way

	Ns	Ls
LM-SA-X0	1	120
LM-SA-X1	4	300
LM-SA-X2	7	480

### LM-PA-X Coil Assembly

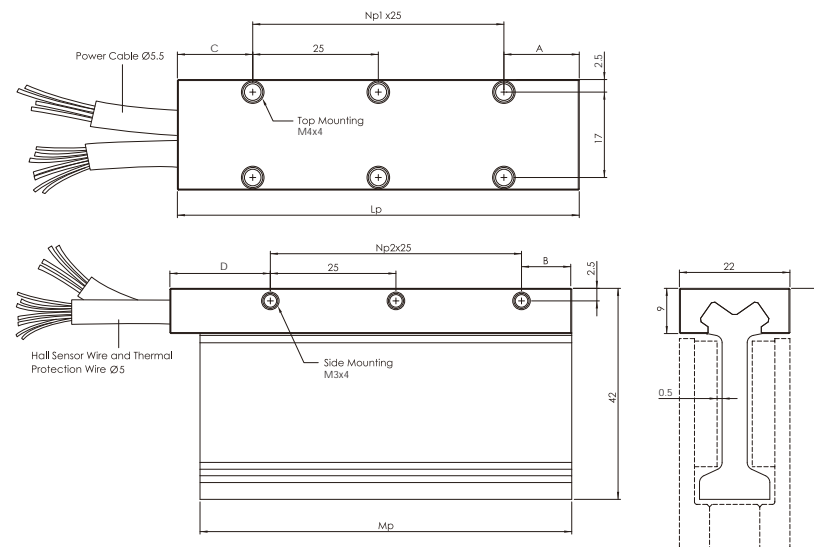

### LM-SA-X Magnetic Way

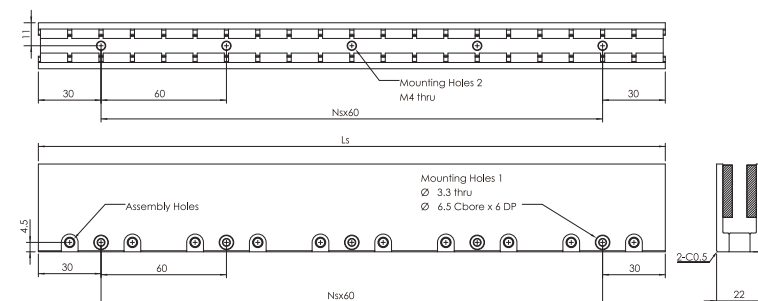

### OUTPUT CABLE (All cable standard length is 400 mm)

Motor Wire Table				Hall Sensor Wire Table and Thermal Protection Wire Table				
Pin Number	Function	Cross section	Color	Function	Cable Dia.	Color	Function	Cable Dia.
White	U phase	0.25 mm <sup>2</sup>	Pink	Hall A U phase	0.14 mm <sup>2</sup>	Brown	Thermal sensor	0.14 mm <sup>2</sup>
Yellow	V phase	0.25 mm <sup>2</sup>	Yellow	Hall B V phase	0.14 mm <sup>2</sup>	Blue		
Brown	W phase	0.25 mm <sup>2</sup>	Green	Hall C W phase	0.14 mm <sup>2</sup>			
Green	PE + shielding	0.25 mm <sup>2</sup>	Grey	Hall IC + 5V	0.14 mm <sup>2</sup>			
			White	GND	0.14 mm <sup>2</sup>			

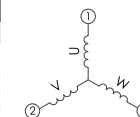

## LM-PB SERIES

Linear Motion Technology

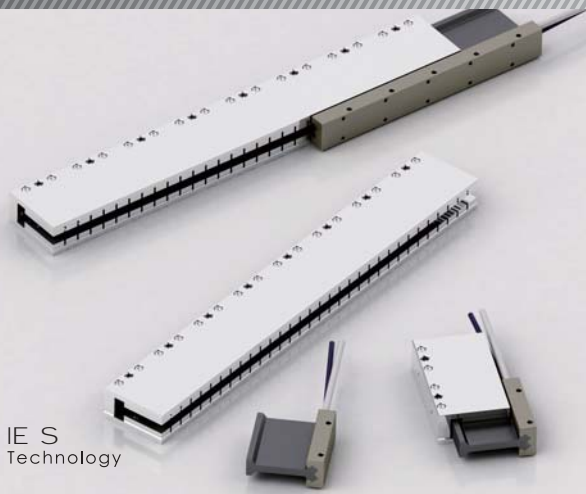

### LM-PB Coil Assembly Model

Coil Assembly Model	LM-PB2		LM-PB3		LM-PB4			LM-PB5		LM-PB6		LM-PB8			
Winding code	W1	W2	W1	W2	W1	W2	W3	W1	W2	W1	W2	W1	W2	W3	W4
<b>Performance<sup>(1)</sup></b>															
Peak force with heat sink(N) <sup>(1)(2)</sup>	180.3		270.4		360.5			428.1		513.7		648.9			
Peak force without heat sink(N) <sup>(2)(3)</sup>	118.3		166.4		207.1			240.4		288.4		468.5			
Continuous force with heat sink(N) <sup>(1)(2)</sup>	45.1		67.6		90.1			107		128.4		162.2			
Continuous force without heat sink(N) <sup>(2)(3)</sup>	29.6		41.6		51.8			60.1		72.1		117.1			
Peak power(W) <sup>(1)(2)</sup>	960		1440		1920			2166		2599.2		3110.4			
Continuous power(W) <sup>(1)(2)</sup>	60		90		120			135.4		162.5		194.4			
<b>Mechanical</b>															
Coil assembly length(mm)	80		110		140			170		200		260			
Coil assembly weight(kg) <sup>(2)</sup>	0.31		0.43		0.54			0.66		0.78		0.9			
Magnetic way weight(kg/m) <sup>(2)</sup>	11.8		11.8		11.8			11.8		11.8		11.8			
Pole pitch(mm)	30		30		30			30		30		30			
<b>Electrical<sup>(4)</sup></b>															
Continuous current with heat sink(A <sub>pk</sub> ) <sup>(2)(3)</sup>	2	4	2	4	2	4	8	1.9	3.8	1.9	3.8	1.8	3.6	7.2	14.4
Continuous current without heat sink(A <sub>pk</sub> ) <sup>(2)(3)</sup>	1.6	3.2	1.5	3	1.4	2.8	5.6	1.3	2.6	1.3	2.6	1.3	2.6	5.2	10.4
Peak current with heat sink(A <sub>pk</sub> ) <sup>(1)(2)</sup>	8	16	8	16	8	16	32	7.6	15.2	7.6	15.2	7.2	14.4	28.8	57.6
Peak current without heat sink(A <sub>pk</sub> ) <sup>(2)(3)</sup>	6.4	12.8	6	12	5.6	11.2	22.4	5.2	10.4	5.2	10.4	5.2	10.4	20.8	41.6
Force constant(N/A <sub>pk</sub> ) <sup>(2)</sup>	22.5	11.3	33.8	16.9	45.1	22.5	11.3	56.3	28.2	67.6	33.8	90.1	45.1	22.5	11.3
Back EMF constant(V <sub>pk(0.1)</sub> / m/s) <sup>(2)</sup>	26.2	13.1	39.3	19.7	52.4	26.2	13.1	65.5	32.8	78.6	39.3	104.8	52.4	26.2	13.1
Resistant(Ohms) <sup>(2)</sup>	15	3.8	22.5	5.6	30	7.5	1.9	37.5	9.4	45	11.3	60	15	3.8	0.9
Inductance(mH) <sup>(2)</sup>	3.5	0.88	5.25	1.31	7	1.75	0.44	8.75	2.19	10.5	2.63	14	3.5	0.88	0.22
Time constant(ms) <sup>(2)</sup>	0.23	0.23	0.23	0.23	0.23	0.23	0.23	0.23	0.23	0.23	0.23	0.23	0.23	0.23	0.23
Thermal resistant with heat sink(°C/W) <sup>(1)(2)</sup>	1.3		0.9		0.8			0.6		0.5		0.5			
Thermal resistant without heat sink(°C/W) <sup>(2)(3)</sup>	2.1		1.7		1.5			1.3		1.1		0.8			
Heat sink(mm)	250x250x25		250x250x25		250x250x25			250x250x25		250x250x25		250x250x25			
Motor constant(N/√W) <sup>(2)</sup>	5.8		7.1		8.2			9.2		10.1		11.6			
Ph-PE dielectric strength <sup>(2)</sup>	≥ 5KV(AC)		≥ 5KV(AC)		≥ 5KV(AC)			≥ 5KV(AC)		≥ 5KV(AC)		≥ 5KV(AC)			
Ph-PE insulation resistance <sup>(2)</sup>	≥ 1KV(DC)		≥ 1KV(DC)		≥ 1KV(DC)			≥ 1KV(DC)		≥ 1KV(DC)		≥ 1KV(DC)			

- (1) Value applies to the static sinusoidal drive, under specific heat sink and temperatures from 25°C to 110°C. Actual performance depends on heat sink configuration, system cooling conditions and the ambient temperature.
- (2) The tolerance of all performance and electrical specification is ±10%.
- (3) The value applies to the static sinusoidal drive at temperatures from 25°C up to 110°C, without heat sink.
- (4) The above "without heat sink" figure assumes a working condition of 1atm at a 25°C ambient temperature, with the stationary linear motor not in contact with any other objects, relying only on air convection for cooling. As all heat conductive objects in direct contact with the linear motor, including the sliding plate, linear guide, and base, can be considered a type of heat sink, the "with heat sink" figure should be taken as the primary reference for actual application design.

### LM-PB Coil Assembly

	Np1	Np2	Lp	Mp	A	B	C	D
LM-PB2	1	1	80	74	5	10	25	20
LM-PB3	1	1	110	104	25	35	35	25
LM-PB4	2	2	140	134	5	15	35	25
LM-PB5	2	2	170	164	35	45	35	25
LM-PB6	3	3	200	194	15	25	35	25
LM-PB8	4	4	260	254	25	35	35	25

### LM-SB Magnetic Way

	Ns	Ls
LM-SB0	1	120
LM-SB1	4	300
LM-SB2	7	480

### LM-PB Coil Assembly

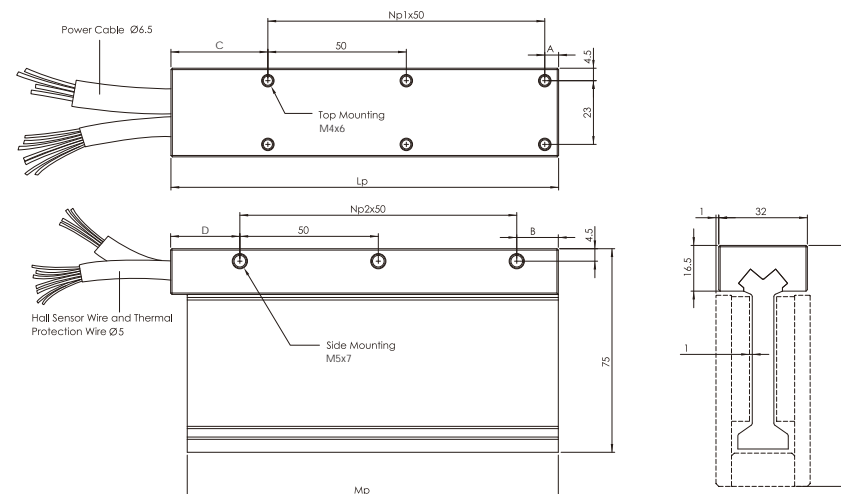

### LM-SB Magnetic Way

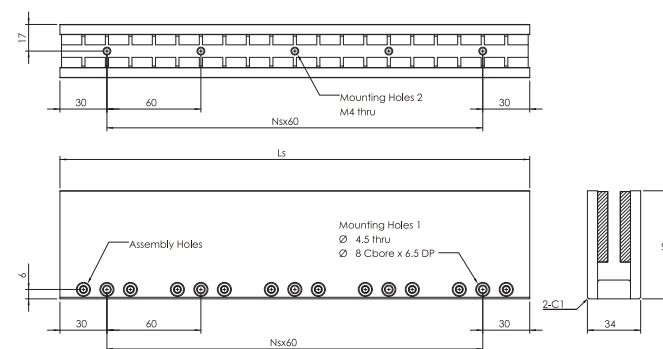

OUTPUT CABLE ( All cable standard length is 400 mm)

Motor Wire Table				Hall Sensor Wire Table and Thermal Protection Wire Table				
Pin Number	Function	Cross section	Color	Function	Cable Dia.	Color	Function	Cable Dia.
	U phase	0.5 mm <sup>2</sup>	Pink	Hall A U phase	0.14 mm <sup>2</sup>	Brown	Thermal sensor	0.14 mm <sup>2</sup>
	V phase	0.5 mm <sup>2</sup>	Yellow	Hall B V phase	0.14 mm <sup>2</sup>	Blue		
	W phase	0.5 mm <sup>2</sup>	Green	Hall C W phase	0.14 mm <sup>2</sup>		Shielding	
	FE + shielding	0.5 mm <sup>2</sup>	Grey	Hall IC + 5V	0.14 mm <sup>2</sup>			
			White	GND	0.14 mm <sup>2</sup>			

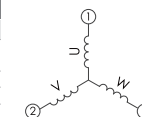

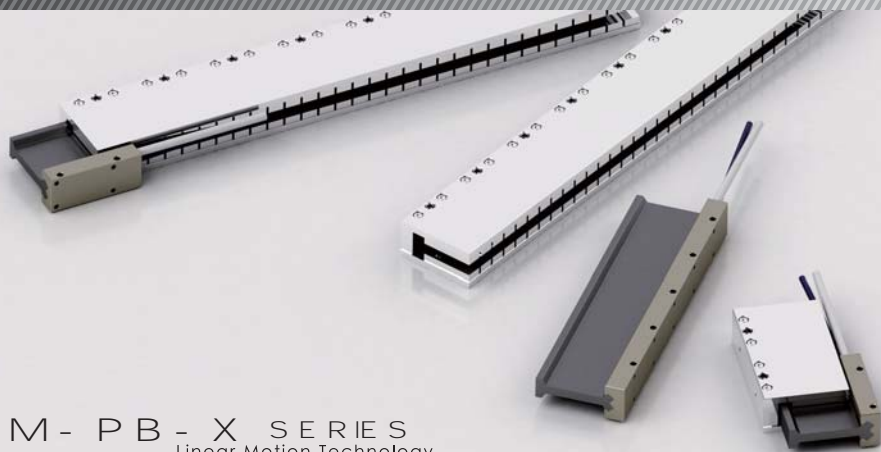

## LM-PB-X SERIES

Linear Motion Technology

### LM-PB-X Coil Assembly Model

Coil Assembly Model	LM-PB-X2		LM-PB-X3		LM-PB-X4			LM-PB-X5		LM-PB-X6		LM-PB-X8			
Winding code	W1	W2	W1	W2	W1	W2	W3	W1	W2	W1	W2	W1	W2	W3	W4
<b>Performance<sup>(1)</sup></b>															
Peak force with heat sink(N) <sup>(1)(2)</sup>	227		340.6		431.4			539.2		613				771.9	
Peak force without heat sink(N) <sup>(2)(3)</sup>	170.3		238.4		295.2			368.9		442.7				590.3	
Continuous force with heat sink(N) <sup>(1)(2)</sup>	56.8		85.1		107.8			134.8		153.3				193	
Continuous force without heat sink(N) <sup>(2)(3)</sup>	42.6		59.6		73.8			92.2		110.7				147.6	
Peak power(W) <sup>(1)(2)</sup>	1056		1584		1906.1			2382.6		2566.1				3051.8	
Continuous power(W) <sup>(1)(2)</sup>	66		99		119.1			148.9		160.4				190.7	
<b>Mechanical</b>															
Coil assembly length(mm)	80		110		140			170		200		260			
Coil assembly weight(kg) <sup>(2)</sup>	0.33		0.44		0.55			0.72		0.9		1.09			
Magnetic way weight(kg/m) <sup>(2)</sup>	12.2		12.2		12.2			12.2		12.2		12.2			
Pole pitch(mm)	30		30		30			30		30		30			
<b>Electrical<sup>(4)</sup></b>															
Continuous current with heat sink(A <sub>pk</sub> ) <sup>(2)(3)</sup>	2	4	2	4	1.9	3.8	7.6	1.9	3.8	1.8	3.6	1.7	3.4	6.8	13.6
Continuous current without heat sink(A <sub>pk</sub> ) <sup>(2)(3)</sup>	1.5	3	1.4	2.8	1.3	2.6	5.2	1.3	2.6	1.3	2.6	1.3	2.6	5.2	10.4
Peak current with heat sink(A <sub>pk</sub> ) <sup>(1)(2)</sup>	8	16	8	16	7.6	15.2	30.4	7.6	15.2	7.2	14.4	6.8	13.6	27.7	54.4
Peak current without heat sink(A <sub>pk</sub> ) <sup>(2)(3)</sup>	6	12	5.6	11.2	5.2	10.4	20.8	5.2	10.4	5.2	10.4	5.2	10.4	20.8	41.6
Force constant(N/A <sub>pk</sub> ) <sup>(2)</sup>	28.4	14.2	42.6	21.3	56.8	28.4	14.2	71	35.5	85.1	42.6	113.5	56.8	28.4	14.2
Back EMF constant(V <sub>pk(q-θ)</sub> / m/s) <sup>(2)</sup>	33	16.5	49.5	24.8	66	33	16.5	82.5	41.3	99	49.5	132	66	33	16.5
Resistant(Ohms) <sup>(2)</sup>	16.5	4.1	24.8	6.2	33	8.3	2.1	41.3	10.3	49.5	12.4	66	16.5	4.1	1
Inductance(mH) <sup>(2)</sup>	5.74	1.44	8.61	2.15	11.48	2.87	0.72	14.35	3.59	17.22	4.31	22.96	5.74	1.44	0.36
Time constant(ms) <sup>(2)</sup>	0.35	0.35	0.35	0.35	0.35	0.35	0.35	0.35	0.35	0.35	0.35	0.35	0.35	0.35	0.35
Thermal resistant with heat sink(°C/W) <sup>(1)(2)</sup>	1.1		0.8		0.7			0.6		0.5		0.4			
Thermal resistant without heat sink(°C/W) <sup>(2)(3)</sup>	1.9		1.6		1.4			1.2		1		0.7			
Heat sink(mm)	250x250x25		250x250x25		250x250x25			250x250x25		250x250x25		250x250x25			
Motor constant(N/√W) <sup>(2)</sup>	7		8.6		9.9			11		12.1		14			
Ph-PE dielectric strength <sup>(2)</sup>	≥ 5KV(AC)		≥ 5KV(AC)		≥ 5KV(AC)			≥ 5KV(AC)		≥ 5KV(AC)		≥ 5KV(AC)			
Ph-PE insulation resistance <sup>(2)</sup>	≥ 1KV(DC)		≥ 1KV(DC)		≥ 1KV(DC)			≥ 1KV(DC)		≥ 1KV(DC)		≥ 1KV(DC)			

- (1) Value applies to the static sinusoidal drive, under specific heat sink and temperatures from 25°C to 110°C. Actual performance depends on heat sink configuration, system cooling conditions and the ambient temperature.
- (2) The tolerance of all performance and electrical specification is ±10%.
- (3) The value applies to the static sinusoidal drive at temperatures from 25°C up to 110°C, without heat sink.
- (4) The above "without heat sink" figure assumes a working condition of 1atm at a 25°C ambient temperature, with the stationary linear motor not in contact with any other objects, relying only on air convection for cooling. As all heat conductive objects in direct contact with the linear motor, including the sliding plate, linear guide, and base, can be considered a type of heat sink, the "with heat sink" figure should be taken as the primary reference for actual application design.

### LM-PB-X Coil Assembly

	Np1	Np2	Lp	Mp	A	B	C	D
LM-PB-X2	1	1	80	74	5	10	25	20
LM-PB-X3	1	1	110	104	25	35	35	25
LM-PB-X4	2	2	140	134	5	15	35	25
LM-PB-X5	2	2	170	164	35	45	35	25
LM-PB-X6	3	3	200	194	15	25	35	25
LM-PB-X8	4	4	260	254	25	35	35	25

### LM-SB-X Magnetic Way

	Ns	Ls
LM-SB-X0	1	120
LM-SB-X1	4	300
LM-SB-X2	7	480

### LM-PB-X Coil Assembly

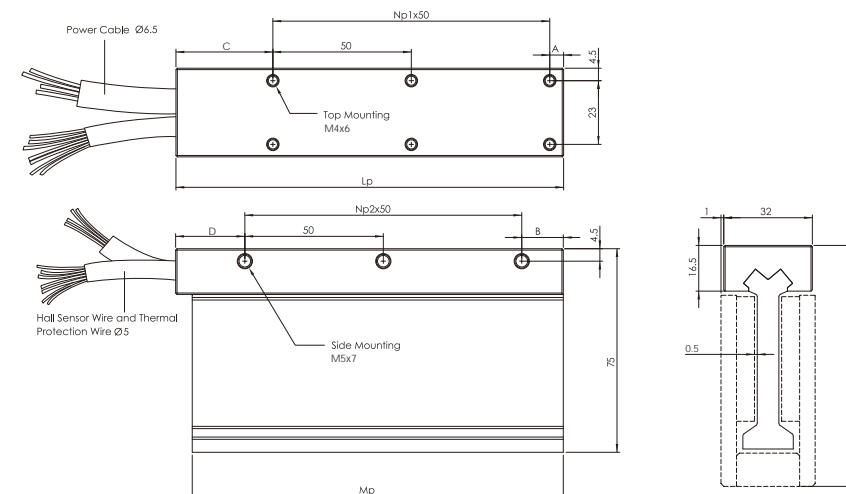

### LM-SB-X Magnetic Way

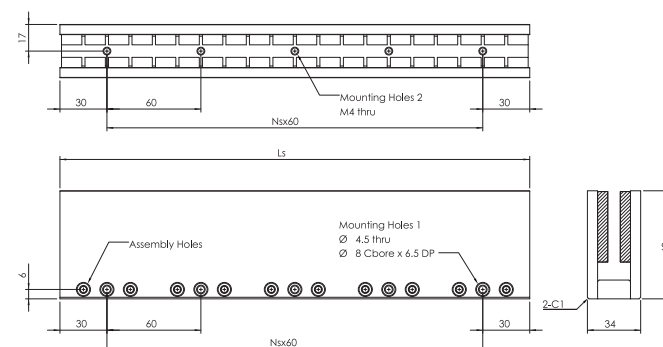

### OUTPUT CABLE ( All cable standard length is 400 mm)

Motor Wire Table				Hall Sensor Wire Table and Thermal Protection Wire Table				
Pin Number	Function	Cross section	Color	Function	Cable Dia.	Color	Function	Cable Dia.
	U phase	0.5 mm <sup>2</sup>	Pink	Hall A U phase	0.14 mm <sup>2</sup>	Brown		
	V phase	0.5 mm <sup>2</sup>	Yellow	Hall B V phase	0.14 mm <sup>2</sup>	Blue	Thermal sensor	0.14 mm <sup>2</sup>
	W phase	0.5 mm <sup>2</sup>	Green	Hall C W phase	0.14 mm <sup>2</sup>			
	PE - shielding	0.5 mm <sup>2</sup>	Grey	Hall IC - 5V	0.14 mm <sup>2</sup>		Shielding	
			White	GND	0.14 mm <sup>2</sup>			

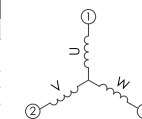

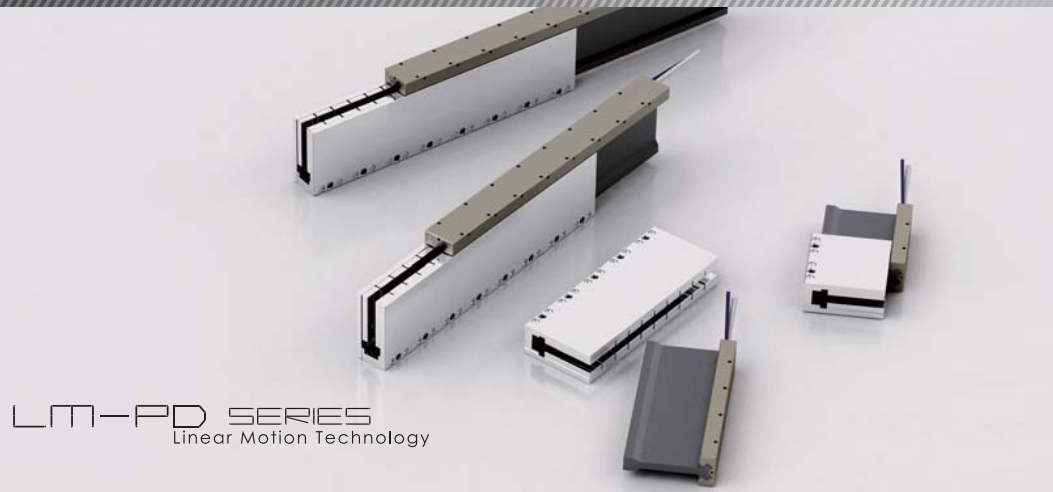

## LM-PD SERIES

Linear Motion Technology

### LM-PD Coil Assembly Model

Coil Assembly Model	LM-PD2			LM-PD4			LM-PD6			LM-PD8			LM-PD10		
Winding code	W1	W2	W3	W1	W2	W3	W1	W2	W3	W1	W2	W3	W1	W2	W3
<b>Performance<sup>(1)</sup></b>															
Peak force with heat sink(N) <sup>(1)(2)</sup>	908.7			1642.7			2464			3075.6			3844.5		
Peak force without heat sink(N) <sup>(2)(3)</sup>	699			1258.2			1887.3			2376.6			2796		
Continuous force with heat sink(N) <sup>(1)(2)</sup>	227.2			410.7			616			768.9			961.1		
Continuous force without heat sink(N) <sup>(2)(3)</sup>	174.8			314.6			471.8			594.2			699		
Peak power(W) <sup>(1)(2)</sup>	2812.2			4594.7			6892.1			8053.8			10067.2		
Continuous power(W) <sup>(1)(2)</sup>	175.8			287.2			430.8			503.4			629.2		
<b>Mechanical</b>															
Coil assembly length(mm)	146			266			386			506			626		
Coil assembly weight(kg) <sup>(2)</sup>	1.3			2.5			3.7			4.9			6.1		
Magnetic way weight(kg/m) <sup>(2)</sup>	29.8			29.8			29.8			29.8			29.8		
Pole pitch(mm)	60			60			60			60			60		
<b>Electrical<sup>(4)</sup></b>															
Continuous current with heat sink(A <sub>pk</sub> ) <sup>(2)(3)</sup>	2.6	5.2	2.4	4.7	9.4	2.4	4.7	14.4	2.2	4.4	8.8	2.2	4.4	11.0	
Continuous current without heat sink(A <sub>pk</sub> ) <sup>(2)(3)</sup>	2	4	1.8	3.6	7.2	1.8	3.6	10.8	1.7	3.4	6.8	1.6	3.2	8.0	
Peak current with heat sink(A <sub>pk</sub> ) <sup>(1)(2)</sup>	10.4	20.8	9.4	18.8	37.6	9.4	18.8	56.4	8.8	17.6	35.2	8.8	17.6	44.0	
Peak current without heat sink(A <sub>pk</sub> ) <sup>(2)(3)</sup>	8	16	7.2	14.4	28.8	7.2	14.4	43.2	6.8	13.6	27.2	6.4	12.8	32.0	
Force constant(N/A <sub>pk</sub> ) <sup>(2)</sup>	87.4	43.7	174.8	87.4	43.7	262.1	131.1	43.7	349.5	174.8	87.4	436.9	218.4	87.4	
Back EMF constant(V <sub>pk(0.1)</sub> / m/s) <sup>(2)</sup>	101.6	50.8	203.2	101.6	50.8	304.8	152.4	50.8	406.4	203.2	101.6	508	254	101.6	
Resistant(Ohms) <sup>(2)</sup>	26	6.5	52	13	3.3	78	19.5	2.2	104	26	6.5	130	32.5	5.3	
Inductance(mH) <sup>(2)</sup>	26.4	6.6	52	13.2	3.3	79	19.8	2.2	105.6	26.4	6.6	132	33	5.3	
Time constant(ms) <sup>(2)</sup>	1.0	1.0	1.0	1.0	1.0	1.0	1.0	1.0	1.0	1.0	1.0	1.0	1.0	1.0	
Thermal resistant with heat sink(°C/W) <sup>(1)(2)</sup>	0.4			0.3			0.2			0.2			0.1		
Thermal resistant without heat sink(°C/W) <sup>(2)(3)</sup>	0.7			0.5			0.3			0.3			0.2		
Heat sink(mm)	800x900x12			800x900x12			800x900x12			800x900x12			800x900x12		
Motor constant(N/√W) <sup>(2)</sup>	17.1			24.2			29.7			34.3			38.3		
Ph-PE dielectric strength <sup>(2)</sup>	≥ 5KV(AC)			≥ 5KV(AC)			≥ 5KV(AC)			≥ 5KV(AC)			≥ 5KV(AC)		
Ph-PE insulation resistance <sup>(2)</sup>	≥ 1KV(DC)			≥ 1KV(DC)			≥ 1KV(DC)			≥ 1KV(DC)			≥ 1KV(DC)		

- (1) Value applies to the static sinusoidal drive, under specific heat sink and temperatures from 25°C to 110°C. Actual performance depends on heat sink configuration, system cooling conditions and the ambient temperature.
- (2) The tolerance of all performance and electrical specification is ±10%.
- (3) The value applies to the static sinusoidal drive at temperatures from 25°C up to 110°C, without heat sink.
- (4) The above "without heat sink" figure assumes a working condition of 1atm at a 25°C ambient temperature, with the stationary linear motor not in contact with any other objects, relying only on air convection for cooling. As all heat conductive objects in direct contact with the linear motor, including the sliding plate, linear guide, and base, can be considered a type of heat sink, the "with heat sink" figure should be taken as the primary reference for actual application design.

### LM-PD Coil Assembly

	Np1	Np2	Lp	Mp	A	B	C	D
LM-PD2	1	1	146	143	26	36	60	50
LM-PD4	3	3	266	263	26	36	60	50
LM-PD6	5	5	386	383	26	36	60	50
LM-PD8	7	7	506	503	26	36	60	50
LM-PD10	9	9	626	623	26	36	60	50

### LM-SD Magnetic Way

	Ns	Ls
LM-SD0	1	120
LM-SD1	4	300
LM-SD2	7	480

### LM-PD Coil Assembly

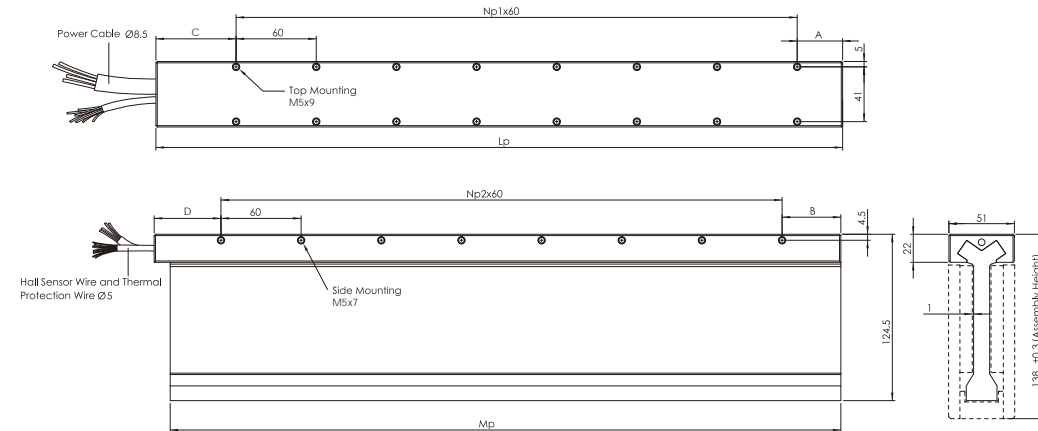

### LM-SD Magnetic Way

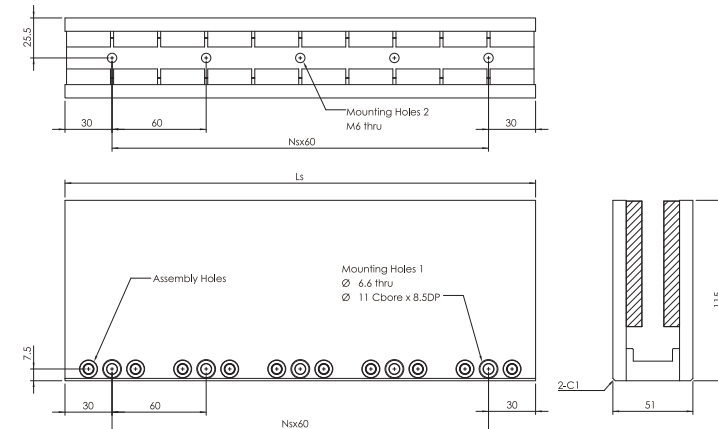

### OUTPUT CABLE ( All cable standard length is 400 mm)

Motor Wire Table			Hall Sensor Wire Table and Thermal Protection Wire Table					
Pin Number	Function	Cross section	Color	Function	Cable Dia.	Color	Function	Cable Dia.
White (1)	U phase	1.5 mm <sup>2</sup>	Pink	Hall A U phase	0.14 mm <sup>2</sup>	Brown	Thermal sensor	0.14 mm <sup>2</sup>
Yellow (2)	V phase	1.5 mm <sup>2</sup>	Yellow	Hall B V phase	0.14 mm <sup>2</sup>	Blue		
Brown (3)	W phase	1.5 mm <sup>2</sup>	Green	Hall C W phase	0.14 mm <sup>2</sup>		Shielding	
Green	PE + shielding	1.5 mm <sup>2</sup>	Grey	Hall IC + 5V	0.14 mm <sup>2</sup>			
			White	GND	0.14 mm <sup>2</sup>			

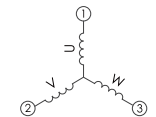

## LM-PD-X SERIES

Linear Motion Technology

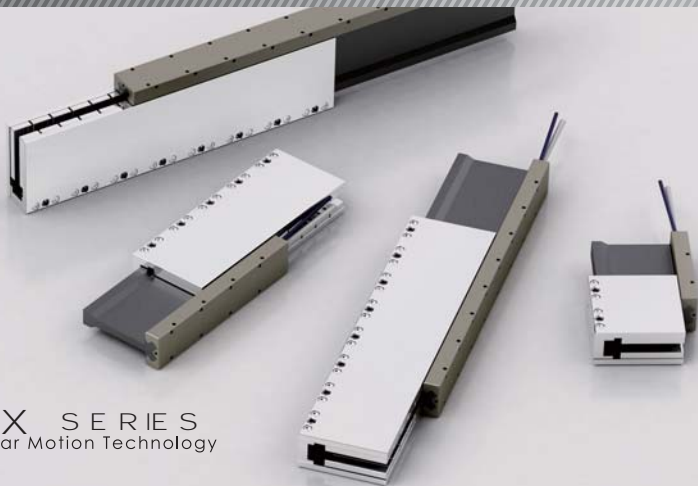

### LM-PD-X Coil Assembly Model

Coil Assembly Model	LM-PD-X2			LM-PD-X4			LM-PD-X6			LM-PD-X8			LM-PD-X10		
Winding code	W1	W2	W3	W1	W2	W3	W1	W2	W3	W1	W2	W3	W1	W2	W3
<b>Performance<sup>(1)</sup></b>															
Peak force with heat sink(N) <sup>(1)(2)</sup>	1025			1892.3			2779.3			3469.2			4336.5		
Peak force without heat sink(N) <sup>(2)(3)</sup>	709.6			1419.2			2069.7			2680.7			3153.8		
Continuous force with heat sink(N) <sup>(1)(2)</sup>	256.2			473.1			694.8			867.3			1084.1		
Continuous force without heat sink(N) <sup>(2)(3)</sup>	177.4			354.8			517.4			670.2			788.4		
Peak power(W) <sup>(1)(2)</sup>	3028.5			5161			7422.2			8673.3			10841.6		
Continuous power(W) <sup>(1)(2)</sup>	189.3			322.6			463.9			542.1			677.6		
<b>Mechanical</b>															
Coil assembly length(mm)	146			266			386			506			626		
Coil assembly weight(kg) <sup>(2)</sup>	1.3			2.8			4.3			5.8			7.3		
Magnetic way weight(kg/m) <sup>(2)</sup>	29.8			29.8			29.8			29.8			29.8		
Pole pitch(mm)	60			60			60			60			60		
<b>Electrical<sup>(4)</sup></b>															
Continuous current with heat sink(A <sub>pk</sub> ) <sup>(2)(3)</sup>	2.6	5.2	2.4	4.7	9.6	2.4	4.7	14.4	2.2	4.4	8.8	2.2	4.4	11.0	11.0
Continuous current without heat sink(A <sub>pk</sub> ) <sup>(2)(3)</sup>	1.8	3.6	1.8	3.6	7.2	1.8	3.5	10.8	1.7	3.4	6.8	1.6	3.2	8.0	8.0
Peak current with heat sink(A <sub>pk</sub> ) <sup>(1)(2)</sup>	10.4	20.8	9.6	19.2	38.4	9.4	18.8	56.4	8.8	17.6	35.2	8.8	17.6	44.0	44.0
Peak current without heat sink(A <sub>pk</sub> ) <sup>(2)(3)</sup>	7.2	14.4	7.2	14.4	28.8	7	14	42	6.8	13.6	27.2	6.4	12.8	32.0	32.0
Force constant(N/A <sub>pk</sub> ) <sup>(2)</sup>	98.6	49.3	197.1	98.6	49.3	295.7	147.8	49.3	394.2	197.1	98.6	492.8	246.4	98.6	98.6
Back EMF constant(V <sub>pk(0.0)</sub> / m/s) <sup>(2)</sup>	114.6	57.3	229.2	114.6	57.3	343.8	171.9	57.3	458.4	229.2	114.6	573	286.5	114.6	114.6
Resistant(Ohms) <sup>(2)</sup>	28	7	56	14	3.5	84	21	2.3	112	28	7	140	35	5.6	5.6
Inductance(mH) <sup>(2)</sup>	30.32	7.58	60.64	15.16	3.79	90.96	22.74	2.53	121.28	30.32	7.58	151.6	37.9	6.06	6.06
Time constant(ms) <sup>(2)</sup>	1.1	1.1	1.1	1.1	1.1	1.1	1.1	1.1	1.1	1.1	1.1	1.1	1.1	1.1	1.1
Thermal resistant with heat sink(°C/W) <sup>(1)(2)</sup>	0.4			0.3			0.2			0.2			0.1		
Thermal resistant without heat sink(°C/W) <sup>(2)(3)</sup>	0.8			0.4			0.3			0.2			0.2		
Heat sink(mm)	800x900x12			800x900x12			800x900x12			800x900x12			800x900x12		
Motor constant(N/√W) <sup>(2)</sup>	18.6			26.3			32.3			37.3			41.6		
Ph-PE dielectric strength <sup>(2)</sup>	≥ 5KV(AC)			≥ 5KV(AC)			≥ 5KV(AC)			≥ 5KV(AC)			≥ 5KV(AC)		
Ph-PE insulation resistance <sup>(2)</sup>	≥ 1KV(DC)			≥ 1KV(DC)			≥ 1KV(DC)			≥ 1KV(DC)			≥ 1KV(DC)		

- (1) Value applies to the static sinusoidal drive, under specific heat sink and temperatures from 25°C to 110°C. Actual performance depends on heat sink configuration, system cooling conditions and the ambient temperature.
- (2) The tolerance of all performance and electrical specification is ±10%.
- (3) The value applies to the static sinusoidal drive at temperatures from 25°C up to 110°C, without heat sink.
- (4) The above "without heat sink" figure assumes a working condition of 1atm at a 25°C ambient temperature, with the stationary linear motor not in contact with any other objects, relying only on air convection for cooling. As all heat conductive objects in direct contact with the linear motor, including the sliding plate, linear guide, and base, can be considered a type of heat sink, the "with heat sink" figure should be taken as the primary reference for actual application design.

### LM-PD-X Coil Assembly

	Np1	Np2	Lp	Mp	A	B	C	D
LM-PD-X2	1	1	146	143	26	36	60	50
LM-PD-X4	3	3	266	263	26	36	60	50
LM-PD-X6	5	5	386	383	26	36	60	50
LM-PD-X8	7	7	506	503	26	36	60	50
LM-PD-X10	9	9	626	623	26	36	60	50

### LM-SD-X Magnetic Way

	Ns	Ls
LM-SD-X0	1	120
LM-SD-X1	4	300
LM-SD-X2	7	480

### LM-PD-X Coil Assembly

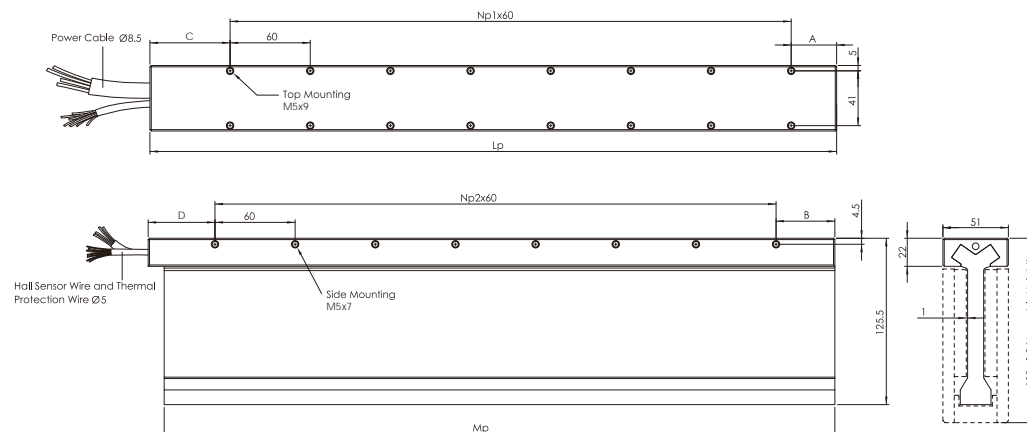

### LM-SD-X Magnetic Way

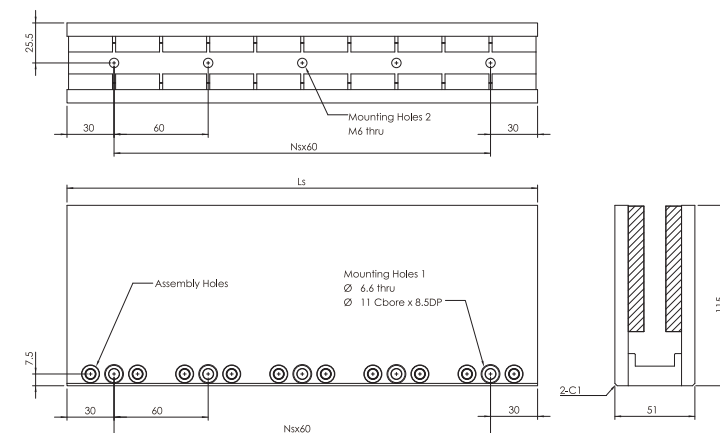

### OUTPUT CABLE ( All cable standard length is 400 mm)

Motor Wire Table			Hall Sensor Wire Table and Thermal Protection Wire Table						
Pin Number	Function	Cross section	Color	Function	Cable Dia.	Color	Function	Cable Dia.	
White (1)	U phase	1.5 mm <sup>2</sup>	Pink	Hall A U phase	0.14 mm <sup>2</sup>	Brown	Thermal sensor	0.14 mm <sup>2</sup>	
Yellow (2)	V phase	1.5 mm <sup>2</sup>	Yellow	Hall B V phase	0.14 mm <sup>2</sup>	Blue			
Brown (3)	W phase	1.5 mm <sup>2</sup>	Green	Hall C W phase	0.14 mm <sup>2</sup>		Shielding		
Green	PE + shielding	1.5 mm <sup>2</sup>	Grey	Hall IC + 5V	0.14 mm <sup>2</sup>				
			White	GND	0.14 mm <sup>2</sup>				

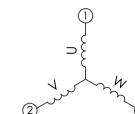



**LM-PDL SERIES**  
Linear Motion Technology

### LM-PDL Coil Assembly Model

Coil Assembly Model	LM-PDL2			LM-PDL4			LM-PDL6			LM-PDL8		
Winding code	W1	W2	W3	W1	W2	W3	W1	W2	W3	W1	W2	W3
<b>Performance<sup>(1)</sup></b>												
Peak force with heat sink(N) <sup>(1)(2)</sup>	657.2			1305.3			1900.3			2457.0		
Peak force without heat sink(N) <sup>(2)(3)</sup>	502.2			998.2			1382.1			1842.7		
Continuous force with heat sink(N) <sup>(1)(2)</sup>	164.4			326.3			475.1			614.2		
Continuous force without heat sink(N) <sup>(2)(3)</sup>	125.7			249.5			345.5			460.7		
Peak power(W) <sup>(1)(2)</sup>	1294.7			2589.4			3659.0			4587.5		
Continuous power(W) <sup>(1)(2)</sup>	80.9			161.8			228.7			286.7		
<b>Mechanical</b>												
Coil assembly length(mm)	148.0			268.0			388.0			508.0		
Coil assembly weight(kg) <sup>(2)</sup>	1.6			2.6			3.6			4.6		
Magnetic way weight(kg/m) <sup>(2)</sup>	25.1			25.1			25.1			25.1		
Pole pitch(mm)	60.0			60.0			60.0			60.0		
<b>Electrical<sup>(4)</sup></b>												
Continuous current with heat sink(A <sub>pk</sub> ) <sup>(1)(2)</sup>	1.7	3.4	6.8	1.7	3.4	6.8	1.7	3.3	10.2	1.6	3.3	6.6
Continuous current without heat sink(A <sub>pk</sub> ) <sup>(2)(3)</sup>	1.3	2.6	5.2	1.3	2.6	5.2	1.2	2.4	7.2	1.2	2.4	4.8
Peak current with heat sink(A <sub>pk</sub> ) <sup>(1)(2)</sup>	6.8	13.6	27.2	6.8	13.6	27.2	6.6	13.2	39.6	6.4	12.8	25.6
Peak current without heat sink(A <sub>pk</sub> ) <sup>(2)(3)</sup>	5.2	10.4	20.8	5.2	10.4	20.8	4.8	9.6	28.8	4.8	9.6	19.2
Force constant(N/A <sub>pk</sub> ) <sup>(2)</sup>	96.7	48.4	24.2	192.0	96.0	48.0	287.9	144.0	48.0	383.9	192.0	96.0
Back EMF constant(V <sub>pk(q-d)</sub> / m/s) <sup>(2)</sup>	111.6	57.3	28.7	223.2	111.6	55.8	334.8	167.4	55.8	446.4	223.2	111.6
Resistant(Ohms) <sup>(2)</sup>	28	7.0	1.8	56.0	14.0	3.5	84.0	21.0	2.3	112.0	28.0	7.0
Inductance(mH) <sup>(2)</sup>	30.32	7.58	1.9	60.64	15.16	3.79	90.96	22.74	2.50	121.28	30.32	7.58
Time constant(ms) <sup>(2)</sup>	1.1	1.1	1.1	1.1	1.1	1.1	1.1	1.1	1.1	1.1	1.1	1.1
Thermal resistant with heat sink(°C/W) <sup>(1)(2)</sup>	1			0.5			0.4			0.3		
Thermal resistant without heat sink(°C/W) <sup>(2)(3)</sup>	1.6			0.8			0.7			0.5		
Heat sink(mm)	800x900x12			800x900x12			800x900x12			800x900x12		
Motor constant(N/√W) <sup>(2)</sup>	18.3			25.7			31.4			36.3		
Ph-PE dielectric strength <sup>(2)</sup>	≥ 5KV(AC)			≥ 5KV(AC)			≥ 5KV(AC)			≥ 5KV(AC)		
Ph-PE insulation resistance <sup>(2)</sup>	≥ 1KV(DC)			≥ 1KV(DC)			≥ 1KV(DC)			≥ 1KV(DC)		

- (1) Value applies to the static sinusoidal drive, under specific heat sink and temperatures from 25°C to 110°C. Actual performance depends on heat sink configuration, system cooling conditions and the ambient temperature.
- (2) The tolerance of all performance and electrical specification is ±10%.
- (3) The value applies to the static sinusoidal drive at temperatures from 25°C up to 110°C, without heat sink.
- (4) The above "without heat sink" figure assumes a working condition of 1atm at a 25°C ambient temperature, with the stationary linear motor not in contact with any other objects, relying only on air convection for cooling. As all heat conductive objects in direct contact with the linear motor, including the sliding plate, linear guide, and base, can be considered a type of heat sink, the "with heat sink" figure should be taken as the primary reference for actual application design.

### LM-PDL Coil Assembly

	Np1	Np2	Lp	Mp	A	B	C	D
LM-PDL2	1	1	148	143	26	38	62	50
LM-PDL4	3	3	268	263	26	38	62	50
LM-PDL6	5	5	388	383	26	38	62	50
LM-PDL8	7	7	508	503	26	38	62	50

### LM-SDL Magnetic Way

	Ns	Ls
LM-SDL0	1	120
LM-SDL1	4	300
LM-SDL2	7	480

### LM-PDL Coil Assembly

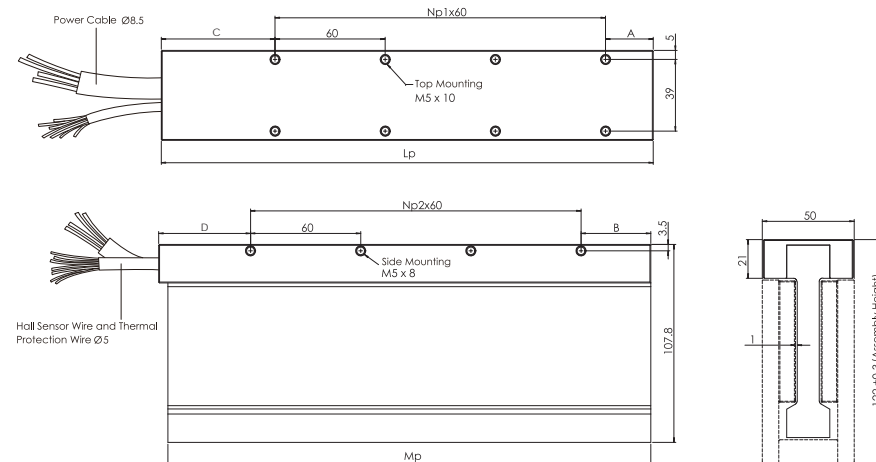

### LM-SDL Magnetic Way

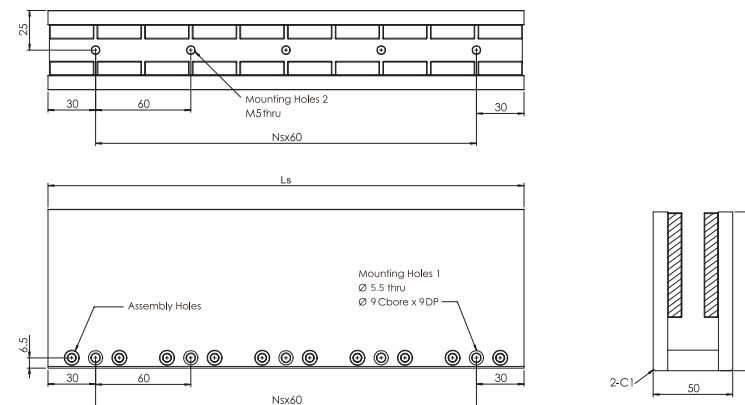

### OUTPUT CABLE ( All cable standard length is 400 mm)

Motor Wire Table				Hall Sensor Wire Table and Thermal Protection Wire Table				
Pin Number	Function	Cross section	Color	Function	Cable Dia.	Color	Function	Cable Dia.
White (1)	U phase	1.5 mm <sup>2</sup>	Pink	Hall A U phase	0.14 mm <sup>2</sup>	Brown	Thermal sensor	0.14 mm <sup>2</sup>
Yellow (2)	V phase	1.5 mm <sup>2</sup>	Yellow	Hall B V phase	0.14 mm <sup>2</sup>	Blue		
Brown (3)	W phase	1.5 mm <sup>2</sup>	Green	Hall C W phase	0.14 mm <sup>2</sup>		Shielding	
Green	PE + shielding	1.5 mm <sup>2</sup>	Grey	Hall IC + 5V	0.14 mm <sup>2</sup>			
			White	GND	0.14 mm <sup>2</sup>			

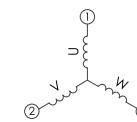

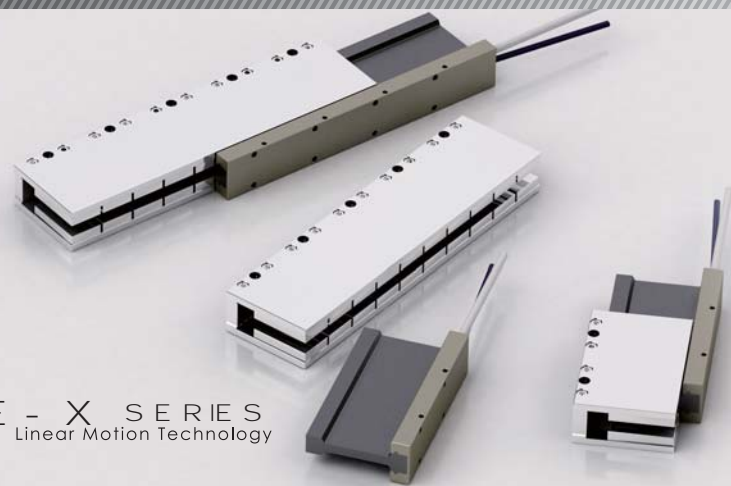

## LM-PE-X SERIES

Linear Motion Technology

### LM-PE-X Coil Assembly Model

Coil Assembly Model	LM-PE-X2			LM-PE-X4			LM-PE-X6			LM-PE-X8		
Winding code	W1	W2	W3	W1	W2	W3	W1	W2	W3	W1	W2	W3
<b>Performance<sup>(1)</sup></b>												
Peak force with heat sink(N) <sup>(1)(2)</sup>	526.7			1053.4			1511.4			1923.6		
Peak force without heat sink(N) <sup>(2)(3)</sup>	389.3			778.6			1099.2			1465.6		
Continuous force with heat sink(N) <sup>(1)(2)</sup>	131.7			263.4			377.9			480.9		
Continuous force without heat sink(N) <sup>(2)(3)</sup>	97.3			194.7			274.8			366.4		
Peak power(W) <sup>(1)(2)</sup>	1269.6			2539.2			3484.8			4233.6		
Continuous power(W) <sup>(1)(2)</sup>	79.4			158.7			217.8			264.6		
<b>Mechanical</b>												
Coil assembly length(mm)	148.0			268.0			388.0			508.0		
Coil assembly weight(kg) <sup>(2)</sup>	0.9			1.5			2.1			2.7		
Magnetic way weight(kg/m) <sup>(2)</sup>	15.0			15.0			15.0			15		
Pole pitch(mm)	60.0			60.0			60.0			60.0		
<b>Electrical<sup>(4)</sup></b>												
Continuous current with heat sink(A <sub>pk</sub> ) <sup>(2)(3)</sup>	2.3	4.6	9.2	2.3	4.6	9.2	2.2	4.4	13.2	2.1	4.2	8.4
Continuous current without heat sink(A <sub>pk</sub> ) <sup>(2)(3)</sup>	1.7	3.4	6.8	1.7	3.4	6.8	1.6	3.2	9.6	1.6	2.4	4.8
Peak current with heat sink(A <sub>pk</sub> ) <sup>(1)(2)</sup>	9.2	18.4	36.8	9.2	18.4	36.8	8.8	17.6	52.8	8.4	16.8	33.6
Peak current without heat sink(A <sub>pk</sub> ) <sup>(2)(3)</sup>	6.8	13.6	27.2	6.8	13.6	27.2	6.4	12.8	38.4	6.4	12.8	25.6
Force constant(N/A <sub>pk</sub> ) <sup>(2)</sup>	57.3	28.6	14.3	114.5	57.3	28.6	171.8	85.9	28.6	229.0	114.5	57.3
Back EMF constant(V <sub>pk(0.1)</sub> / m/s) <sup>(2)</sup>	66.1	33.1	16.5	132.2	66.1	33.1	198.3	99.2	33.1	264.4	132.2	66.1
Resistant(Ohms) <sup>(2)</sup>	15	3.8	0.9	30.0	7.5	1.9	45.0	11.3	1.3	60.0	15.0	3.8
Inductance(mH) <sup>(2)</sup>	12.89	3.22	0.81	25.78	6.45	1.61	38.67	9.67	1.07	51.56	12.89	3.22
Time constant(ms) <sup>(2)</sup>	0.9	0.9	0.9	0.9	0.9	0.9	0.9	0.9	0.9	0.9	0.9	0.9
Thermal resistant with heat sink(°C/W) <sup>(1)(2)</sup>	1			0.5			0.4			0.3		
Thermal resistant without heat sink(°C/W) <sup>(2)(3)</sup>	1.6			0.9			0.7			0.5		
Heat sink(mm)	250x500x25			250x500x25			250x500x25			250x500x25		
Motor constant(N/√W) <sup>(2)</sup>	14.8			20.9			25.6			29.6		
Ph-PE dielectric strength <sup>(2)</sup>	≥ 5KV(AC)			≥ 5KV(AC)			≥ 5KV(AC)			≥ 5KV(AC)		
Ph-PE insulation resistance <sup>(2)</sup>	≥ 1KV(DC)			≥ 1KV(DC)			≥ 1KV(DC)			≥ 1KV(DC)		

- (1) Value applies to the static sinusoidal drive, under specific heat sink and temperatures from 25°C to 110°C. Actual performance depends on heat sink configuration, system cooling conditions and the ambient temperature.
- (2) The tolerance of all performance and electrical specification is ±10%.
- (3) The value applies to the static sinusoidal drive at temperatures from 25°C up to 110°C, without heat sink.
- (4) The above "without heat sink" figure assumes a working condition of 1atm at a 25°C ambient temperature, with the stationary linear motor not in contact with any other objects, relying only on air convection for cooling. As all heat conductive objects in direct contact with the linear motor, including the sliding plate, linear guide, and base, can be considered a type of heat sink, the "with heat sink" figure should be taken as the primary reference for actual application design.

### LM-PE-X Coil Assembly

	Np1	Np2	Lp	Mp	A	B	C	D
LM-PE-X2	1	1	148	143	26	38	62	50
LM-PE-X4	3	3	268	263	26	38	62	50
LM-PE-X6	5	5	388	383	26	38	62	50
LM-PE-X8	7	7	508	503	26	38	62	50

### LM-SE-X Magnetic Way

	Ns	Ls
LM-SE-X0	1	120
LM-SE-X1	4	300
LM-SE-X2	7	480

### LM-PE-X Coil Assembly

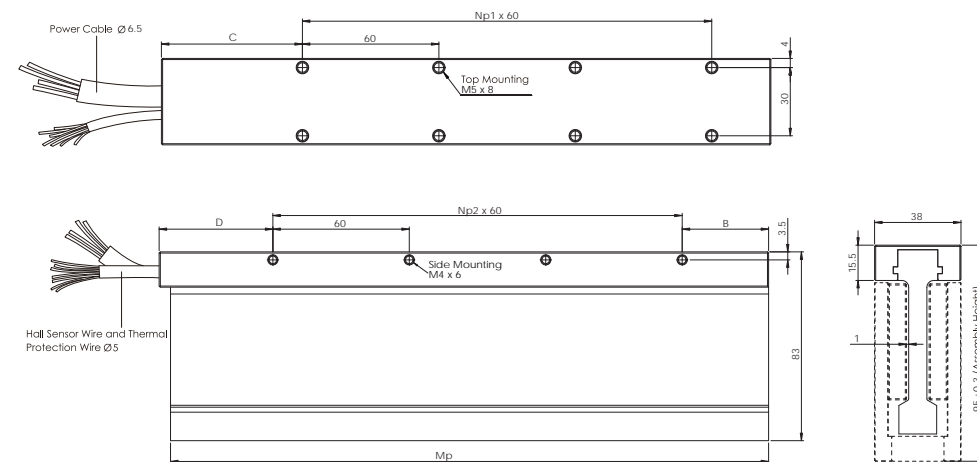

### LM-SE-X Magnetic Way

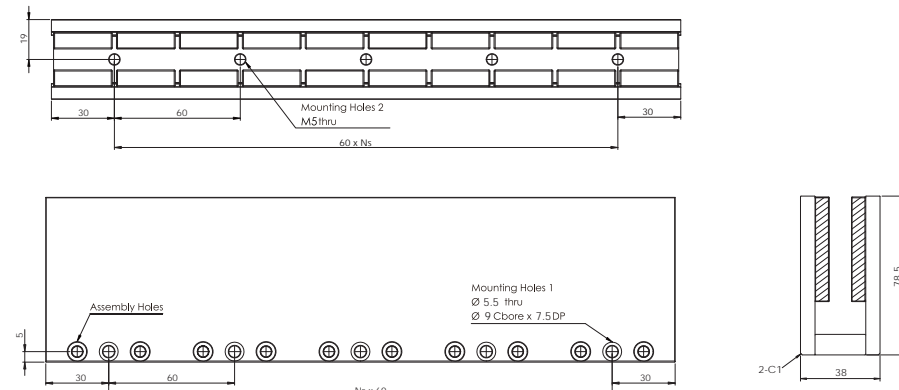

### OUTPUT CABLE (All cable standard length is 400 mm)

Motor Wire Table			Hall Sensor Wire Table and Thermal Protection Wire Table					
Pin Number	Function	Cross section	Color	Function	Cable Dia.	Color	Function	Cable Dia.
White	U phase	0.5 mm <sup>2</sup>	Pink	Hall A U phase	0.14 mm <sup>2</sup>	Brown	Thermal sensor	0.14 mm <sup>2</sup>
Yellow	V phase	0.5 mm <sup>2</sup>	Yellow	Hall B V phase	0.14 mm <sup>2</sup>	Blue	Shielding	
Brown	W phase	0.5 mm <sup>2</sup>	Green	Hall C W phase	0.14 mm <sup>2</sup>			
Green	PE + shielding	0.5 mm <sup>2</sup>	Grey	Hall IC + 5V	0.14 mm <sup>2</sup>			
			White	GND	0.14 mm <sup>2</sup>			

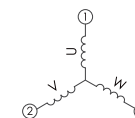



Ironcore Linear Motor Series

## Ironcore Linear Motor

### Construction & Features

Iron core linear motors are suitable for use in point to point, high acceleration, velocity and load linear motion applications.

### Structure

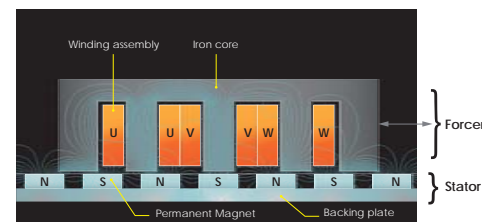

- **cpc** linear motors are composed of two parts: The stator and the forcer.
- The forcer is made by combining coil windings with an iron core which is encapsulated by epoxy inside an outer aluminum shell.
- The stator is composed of arrays of permanent magnets on a ferromagnetic backing plate. The magnets are arranged in an N-S pole pattern, forming a closed magnetic field loop with the forcer iron core.

### Advantages



- **High Force Density**  
Due to stronger magnetic coupling between the iron core and the stator magnets, iron core linear motors have a relatively higher force output than ironless linear motors.
- **High Heat Dissipation**  
The iron core provides a dissipation path for the heat produced by the coils during operation. This significantly reduces coil-to-ambient thermal resistance as compared with ironless linear motors.
- **Easy assembly**  
For iron core linear motors, the mutually facing forcer and stator make the product much easier to assemble.

### cpc Features

- **cpc** For motor parameters, force constant refers to the amount of force produced per one ampere of current, while motor constant refers to the force produced per Watt and is representative of the motor's efficiency. As such, the motor constant is a better metric at evaluating motor performance. **cpc**'s linear motors have been designed with the aid of advanced simulation software. As a result, for this metric, **cpc** motors have a higher motor constant.

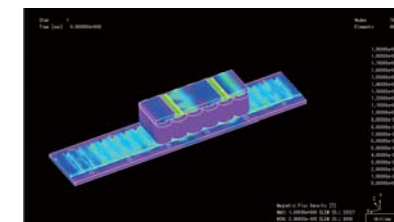

### Low Cogging Force

Cogging force originates from the drastic alterations in magnetism on the iron core during transitions across the different magnetic poles on the stator. In this way, by skewing the magnets, the magnetic changes can be lowered. By using advanced software analysis to do so, **cpc** has arrived at a design with an exceptionally low cogging force.

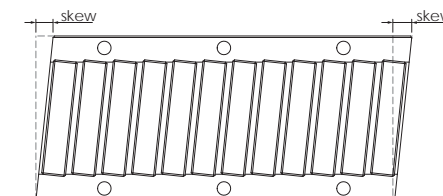

### Heat Dissipative Case

In a **cpc** iron core motor, the outer casing is made of aluminum, increasing its heat dissipation area and lowering thermal resistance.

### Integrated Hall Sensor and Temperature Switch

The **cpc** motor forcer fully utilizes its internal volume, integrating hall sensors and an overheating detection switch, saving the need for the customer to buy or install these as optional extras.

### Applications

1. Automated storage
2. Pick & Place
3. Industrial Automation
4. Semiconductors
5. Medical equipment
6. PCB industry
7. Printing industry



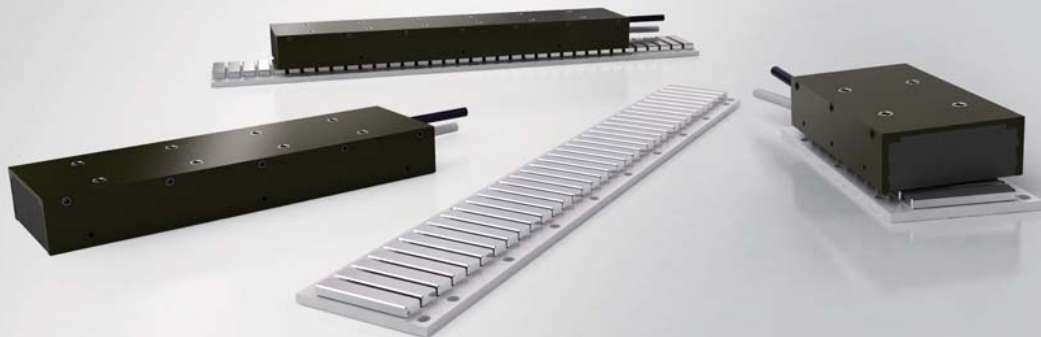

LM-CA-55 series  
Linear Motion Technology

## LM-CA-55 Coil Assembly Model

Coil Assembly Model	LM-CA2-55			LM-CA4-55			LM-CA6-55		
	S	P	D	SP	P	D	SP	P	D
<b>Performance<sup>(1)</sup></b>									
Peak force(N) <sup>(2)(3)</sup>	242.1			484.2			726.3		
Continuous force with heat sink(N) <sup>(1)(2)</sup>	94.2			188.3			282.5		
Continuous force without heat sink(N) <sup>(2)(3)</sup>	53.8			107.6			161.4		
Peak force in linear range(N)	174.9			349.7			524.6		
Attraction force(N)	350.0			700.0			1050		
Peak power(W) <sup>(2)</sup>	540			1080			1620		
Continuous power(W) <sup>(1)(2)</sup>	66.2			132.3			198.5		
<b>Mechanical</b>									
Coil assembly length(mm)	97			177			257		
Coil assembly weight(kg) <sup>(2)</sup>	0.6			1.1			1.6		
Magnetic way weight(kg/m) <sup>(2)</sup>	2.6			2.6			2.6		
Pole pitch(mm)	20			20			20		
<b>Electrical<sup>(4)</sup></b>									
Continuous current with heat sink(A <sub>pk</sub> ) <sup>(2)(3)</sup>	1.8	3.5	7.0	3.5	7.0	14.4	3.5	10.5	21.0
Continuous current without heat sink(A <sub>pk</sub> ) <sup>(2)(3)</sup>	1.0	2.0	4.0	2.0	4.0	8.0	2.0	6.0	12.0
Peak current <sup>(2)(3)</sup>	5.0	10.0	20.0	10.0	20.0	40.0	10.0	30.0	60.0
Peak current in linear range(N)	3.3	6.5	13.2	6.6	13.2	20.0	6.6	19.8	40.0
Force constant(N/A <sub>pk</sub> ) <sup>(2)</sup>	53.8	26.9	13.5	53.8	26.9	13.5	80.7	26.9	13.5
Back EMF constant(V/m/s) <sup>(2)</sup>	67.4	33.7	16.9	67.4	33.7	16.9	101.1	33.7	16.9
Resistance (Ohms) <sup>(2)</sup>	21.6	5.4	1.4	10.8	2.7	0.7	16.2	1.8	0.5
Inductance(mH) <sup>(2)</sup>	100.00	25.00	3.92	50.00	12.50	1.96	75.00	8.30	1.40
Time constant(ms) <sup>(2)</sup>	4.6	4.6	2.8	4.6	4.6	2.8	4.6	4.6	2.8
Thermal resistant with heat sink(°C/W) <sup>(1)(2)</sup>	1.1			0.6			0.4		
Thermal resistant without heat sink(°C/W) <sup>(2)(3)</sup>	3.4			1.7			1.1		
Motor constant(N/√W) <sup>(2)</sup>	11.6			16.4			20.1		

(1) Value applies to the static sinusoidal drive, under specific heat sink and temperatures from 25°C to 110 °C. Actual performance depends on heat sink configuration, system cooling conditions and the ambient temperature.

(2) The tolerance of all performance and electrical specification is ±10%.

(3) The value applies to the static sinusoidal drive at temperatures from 25°C up to 110°C, without heat sink.

(4) The above "without heat sink" figure assumes a working condition of 1atm a 25°C ambient temperature, with the stationary linear motor not in contact with any other objects, relying only on air convection for cooling. As all heat conductive objects in direct contact with the linear motor, including the slide plate, linear guide and base, can be considered a type of heat sink, the "with heat sink" figure should be taken as the primary reference for actual application design.

## LM-CA-55 Coil Assembly

	Np1	Lp
LM-CA2-55	1	97
LM-CA4-55	3	177
LM-CA6-55	5	257

## LM-MA-55 Magnetic Way

	Ns	Lt	Ls	Ls1
LM-MA0-55	2	126	120	110
LM-MA1-55	8	366	360	350
LM-MA2-55	11	486	480	470

## Current VS Force.

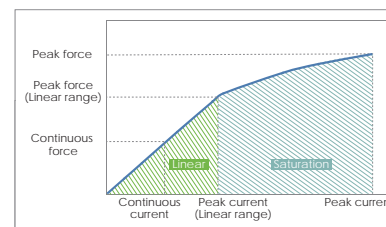

When the motor is operating in its linear sphere, its thrust output is directly proportional to the input current while measuring at a constant value. When operating in the saturation sphere, thrust output is not directly proportional to the input current due to magnetic saturation, resulting in a lower thrust output increase.

## LM-CA-55 Coil Assembly

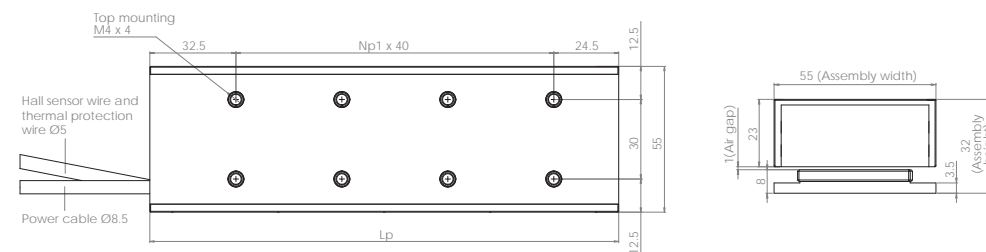

## LM-MA-55 Magnetic Way

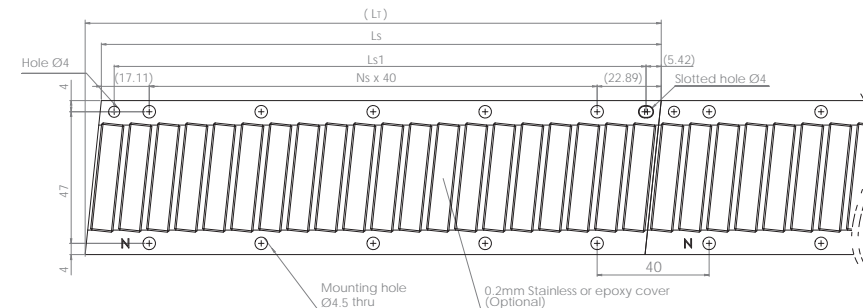

OUTPUT CABLE (All cable standard length is 400 mm)

Motor Wire Table			Hall Sensor Wire Table and Thermal Protection Wire Table					
Pin Number	Function	Cross section	Color	Function	Cable Dia.	Color	Function	Cable Dia.
White (1)	U phase	1.5 mm <sup>2</sup>	Pink	Hall A U phase	0.14 mm <sup>2</sup>	Brown	Thermal sensor	0.14 mm <sup>2</sup>
Yellow (2)	V phase	1.5 mm <sup>2</sup>	Yellow	Hall B V phase	0.14 mm <sup>2</sup>	Blue		
Brown (3)	W phase	1.5 mm <sup>2</sup>	Green	Hall C W phase	0.14 mm <sup>2</sup>		Shielding	
Green	PE + shielding	1.5 mm <sup>2</sup>	Grey	Hall IC + 5V	0.14 mm <sup>2</sup>			
			White	GND	0.14 mm <sup>2</sup>			

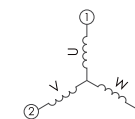

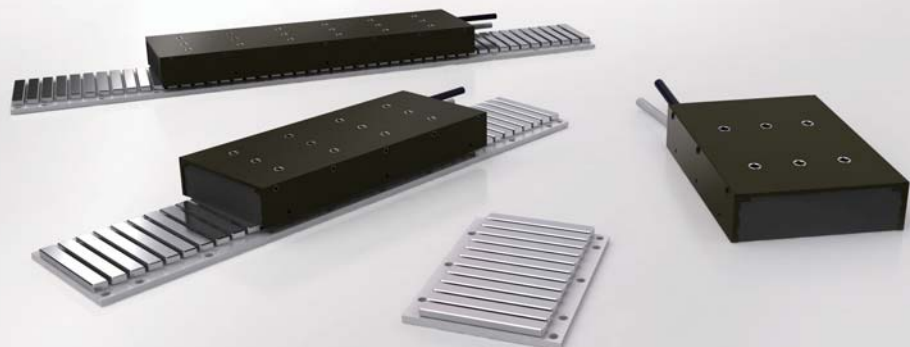

LM-CA-75 series  
Linear Motion Technology

## Current VS Force.

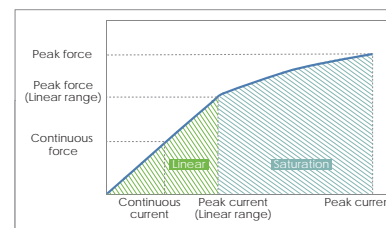

When the motor is operating in its linear sphere, its thrust output is directly proportional to the input current while measuring at a constant value. When operating in the saturation sphere, thrust output is not directly proportional to the input current due to magnetic saturation, resulting in a lower thrust output increase.

## LM-CA-75 Coil Assembly

## LM-CA-75 Coil Assembly Model

Coil Assembly Model	LM-CA2-75			LM-CA4-75			LM-CA6-75	
	S	P	D	SP	P	D	P	D
Winding code								
Performance <sup>(4)</sup>								
Peak force(N) <sup>(2)(3)</sup>		368.0			736.0			1104.0
Continuous force with heat sink(N) <sup>(1)(2)</sup>		143.1			286.2			429.3
Continuous force without heat sink(N) <sup>(2)(3)</sup>		81.8			163.6			245.3
Peak force in linear range(N)		265.8			531.5			797.3
Attraction force(N)		505			1009			1514
Peak power(W) <sup>(2)</sup>		740			1480			2220
Continuous power(W) <sup>(1)(2)</sup>		90.7			181.3			272.0
Mechanical								
Coil assembly length(mm)		97			177			257
Coil assembly weight(kg) <sup>(2)</sup>		0.8			1.5			2.2
Magnetic way weight(kg/m) <sup>(2)</sup>		3.5			3.5			3.5
Pole pitch(mm)		20			20			20
Electrical <sup>(4)</sup>								
Continuous current with heat sink(A <sub>pk</sub> ) <sup>(2)(3)</sup>	1.8	3.5	7.0	3.5	7.0	14.0	10.5	21.0
Continuous current without heat sink(A <sub>pk</sub> ) <sup>(2)(3)</sup>	1.0	2.0	4.0	2.0	4.0	8.0	6.0	12.0
Peak current <sup>(2)(3)</sup>	5.0	10.0	20.0	10.0	20.0	40.0	30.0	60.0
Peak current in linear range(N)	3.3	6.5	13.2	6.6	13.2	20.0	19.8	39.6
Force constant(N/A <sub>pk</sub> ) <sup>(2)</sup>	81.8	40.9	20.4	81.8	40.9	20.4	40.9	20.4
Back EMF constant(V/m/s) <sup>(2)</sup>	102.4	51.2	25.6	102.4	51.2	25.6	51.2	25.6
Resistance (Ohms) <sup>(2)</sup>	29.6	7.4	1.9	14.8	3.7	0.9	2.5	0.6
Inductance(mH) <sup>(2)</sup>	137.03	34.26	5.70	68.52	17.13	2.70	11.40	1.80
Time constant(ms) <sup>(2)</sup>	4.6	4.6	3.0	4.6	4.6	3.0	4.6	3.0
Thermal resistant with heat sink(°C/W) <sup>(1)(2)</sup>		0.8			0.4			0.3
Thermal resistant without heat sink(°C/W) <sup>(2)(3)</sup>		2.5			1.2			0.8
Motor constant(N/√W) <sup>(2)</sup>		15.0			21.3			26.0

(1) Value applies to the static sinusoidal drive, under specific heat sink and temperatures from 25°C to 110°C. Actual performance depends on heat sink configuration, system cooling conditions and the ambient temperature.

(2) The tolerance of all performance and electrical specification is ±10%.

(3) The value applies to the static sinusoidal drive at temperatures from 25°C up to 110°C, without heat sink.

(4) The above "without heat sink" figure assumes a working condition of 1atm a 25°C ambient temperature, with the stationary linear motor not in contact with any other objects, relying only on air convection for cooling. As all heat conductive objects in direct contact with the linear motor, including the slide plate, linear guide and base, can be considered a type of heat sink, the "with heat sink" figure should be taken as the primary reference for actual application design.

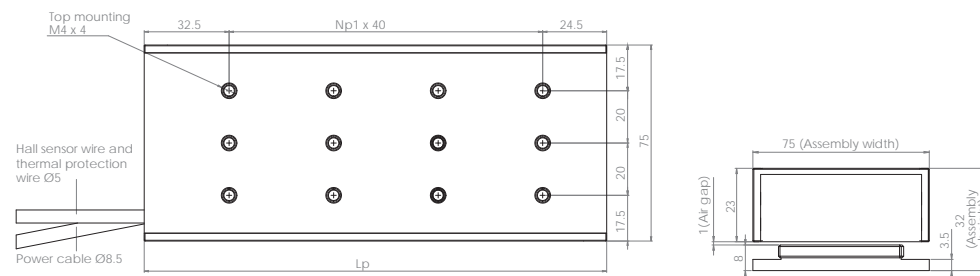

## LM-MA-75 Magnetic Way

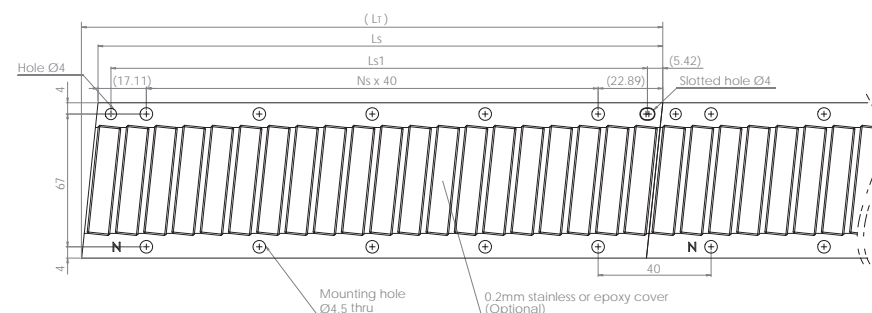

OUTPUT CABLE (All cable standard length is 400 mm)

Motor Wire Table			Hall Sensor Wire Table and Thermal Protection Wire Table					
Pin Number	Function	Cross section	Color	Function	Cable Dia.	Color	Function	Cable Dia.
White (1)	U phase	1.5 mm <sup>2</sup>	Pink	Hall A U phase	0.14 mm <sup>2</sup>	Brown	Thermal sensor	0.14 mm <sup>2</sup>
Yellow (2)	V phase	1.5 mm <sup>2</sup>	Yellow	Hall B V phase	0.14 mm <sup>2</sup>	Blue		
Brown (3)	W phase	1.5 mm <sup>2</sup>	Green	Hall C W phase	0.14 mm <sup>2</sup>		Shielding	
Green	PE + shielding	1.5 mm <sup>2</sup>	Grey	Hall IC + 5V	0.14 mm <sup>2</sup>			
			White	GND	0.14 mm <sup>2</sup>			

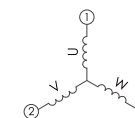

## LM-CA-75 Coil Assembly

	Np1	Lp
LM-CA2-75	1	97
LM-CA4-75	3	177
LM-CA6-75	5	257

## LM-MA-75 Magnetic Way

	Ns	Lt	Ls	Ls1
LM-MA0-75	2	126	120	110
LM-MA1-75	8	366	360	350
LM-MA2-75	11	486	480	470



LM-CA-115 series  
Linear Motion Technology

## Current VS Force.

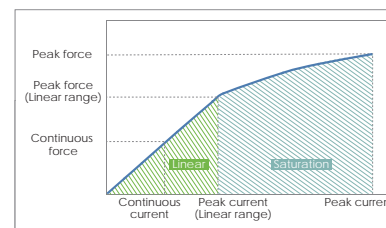

When the motor is operating in its linear sphere, its thrust output is directly proportional to the input current while measuring at a constant value. When operating in the saturation sphere, thrust output is not directly proportional to the input current due to magnetic saturation, resulting in a lower thrust output increase.

## LM-CA-115 Coil Assembly Model

Coil Assembly Model	LM-CA2-115		LM-CA4-115		LM-CA6-115	
	P	D	P	D	P	D
Winding code						
Performance <sup>(1)</sup>						
Peak force(N) <sup>(2)(3)</sup>	588.8		1177.6		1766.4	
Continuous force with heat sink(N) <sup>(1)(2)</sup>	229.0		457.9		686.9	
Continuous force without heat sink(N) <sup>(2)(3)</sup>	130.8		261.7		392.5	
Peak force in linear range(N)	454.5		909.0		1363.5	
Attraction force(N)	896		1792		2688	
Peak power(W) <sup>(2)</sup>	1020		2040		3060	
Continuous power(W) <sup>(1)(2)</sup>	124.9		249.9		374.8	
Mechanical						
Coil assembly length(mm)	97		177		257	
Coil assembly weight(kg) <sup>(2)</sup>	1.5		2.8		4.1	
Magnetic way weight(kg/m) <sup>(2)</sup>	6.7		6.7		6.7	
Pole pitch(mm)	20		20		20	
Electrical <sup>(4)</sup>						
Continuous current with heat sink(A <sub>pk</sub> ) <sup>(2)(3)</sup>	3.3	6.7	6.7	13.3	10.0	20.0
Continuous current without heat sink(A <sub>pk</sub> ) <sup>(2)(3)</sup>	1.9	3.8	3.8	7.6	5.7	11.4
Peak current <sup>(2)(3)</sup>	9.5	19.0	19.0	38.0	28.5	57.0
Peak current in linear range(N)	6.6	13.2	13.2	26.4	16.5	39.6
Force constant(N/A <sub>pk</sub> ) <sup>(2)</sup>	68.9	34.4	68.9	34.4	68.9	34.4
Back EMF constant(V/m/s) <sup>(2)</sup>	86.3	43.1	86.3	43.1	86.3	43.1
Resistance (Ohms) <sup>(2)</sup>	11.3	2.8	5.65	1.41	3.8	0.9
Inductance(mH) <sup>(2)</sup>	52.31	8.68	26.16	4.37	17.40	2.79
Time constant(ms) <sup>(2)</sup>	4.6	3.1	4.6	3.1	4.6	3.1
Thermal resistant with heat sink(°C/W) <sup>(1)(2)</sup>	0.6		0.3		0.2	
Thermal resistant without heat sink(°C/W) <sup>(2)(3)</sup>	1.8		0.9		0.6	
Motor constant(N/√W) <sup>(2)</sup>	20.5		29.0		35.5	

(1) Value applies to the static sinusoidal drive, under specific heat sink and temperatures from 25°C to 110 °C. Actual performance depends on heat sink configuration, system cooling conditions and the ambient temperature.

(2) The tolerance of all performance and electrical specification is ±10%.

(3) The value applies to the static sinusoidal drive at temperatures from 25°C up to 110°C, without heat sink.

(4) The above "without heat sink" figure assumes a working condition of 1atm a 25°C ambient temperature, with the stationary linear motor not in contact with any other objects, relying only on air convection for cooling. As all heat conductive objects in direct contact with the linear motor, including the slide plate, linear guide and base, can be considered a type of heat sink, the "with heat sink" figure should be taken as the primary reference for actual application design.

## LM-CA-115 Coil Assembly

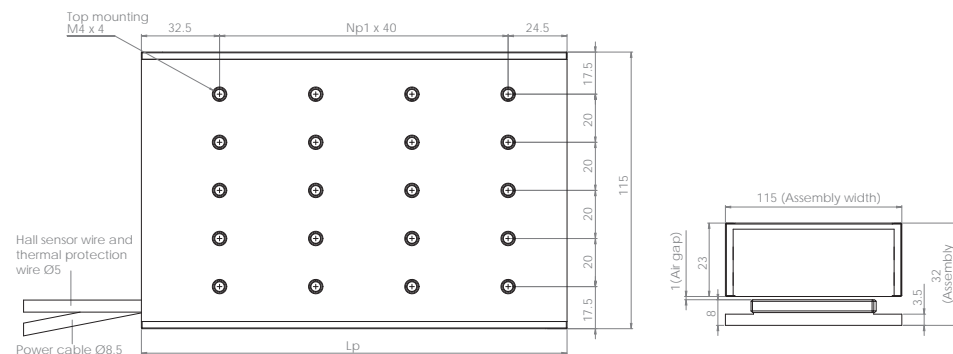

## LM-MA-115 Magnetic Way

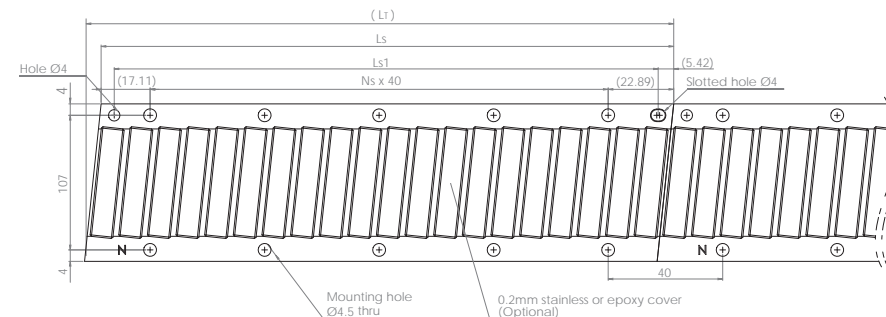

OUTPUT CABLE (All cable standard length is 400 mm)

Motor Wire Table			Hall Sensor Wire Table and Thermal Protection Wire Table					
Pin Number	Function	Cross section	Color	Function	Cable Dia.	Color	Function	Cable Dia.
White (1)	U phase	1.5 mm <sup>2</sup>	Pink	Hall A U phase	0.14 mm <sup>2</sup>	Brown	Thermal sensor	0.14 mm <sup>2</sup>
Yellow (2)	V phase	1.5 mm <sup>2</sup>	Yellow	Hall B V phase	0.14 mm <sup>2</sup>	Blue		
Brown (3)	W phase	1.5 mm <sup>2</sup>	Green	Hall C W phase	0.14 mm <sup>2</sup>		Shielding	
Green	PE + shielding	1.5 mm <sup>2</sup>	Grey	Hall IC + 5V	0.14 mm <sup>2</sup>			
			White	GND	0.14 mm <sup>2</sup>			

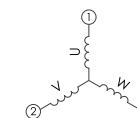

## LM-CA-115 Coil Assembly

	Np1	Lp
LM-CA2-115	1	97
LM-CA4-115	3	177
LM-CA6-115	5	257

## LM-MA-115 Magnetic Way

	Ns	Lt	Ls	Ls1
LM-MA0-115	2	126	120	110
LM-MA1-115	8	366	360	350
LM-MA2-115	11	486	480	470



LM-CB-60 series  
Linear Motion Technology

## Current VS Force.

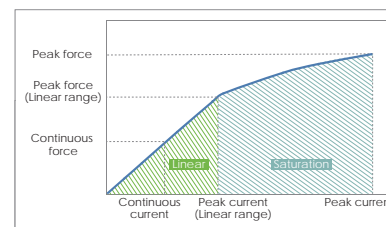

When the motor is operating in its linear sphere, its thrust output is directly proportional to the input current while measuring at a constant value. When operating in the saturation sphere, thrust output is not directly proportional to the input current due to magnetic saturation, resulting in a lower thrust output increase.

## LM-CB-60 Coil Assembly

### LM-CB-60 Coil Assembly Model

Coil Assembly Model	LM-CB2-60			LM-CB4-60			LM-CB6-60	
Winding code	S	P	D	SP	P	D	P	D
<b>Performance<sup>(1)</sup></b>								
Peak force(N) <sup>(2)(3)</sup>	563			1117.4			1680.3	
Continuous force with heat sink(N) <sup>(1)(2)</sup>	198.2			396.5			594.7	
Continuous force without heat sink(N) <sup>(2)(3)</sup>	132.2			264.3			396.5	
Peak force in linear range(N)	283.2			566.4			849.6	
Attraction force(N)	630			1260			1890	
Peak power(W) <sup>(2)</sup>	862			1698			2560	
Continuous power(W) <sup>(1)(2)</sup>	84.7			169.3			254.0	
<b>Mechanical</b>								
Coil assembly length(mm)	130			250			370	
Coil assembly weight(kg) <sup>(2)</sup>	1.6			3.1			4.6	
Magnetic way weight(kg/m) <sup>(2)</sup>	3.0			3.0			3.0	
Pole pitch(mm)	30			30			30	
<b>Electrical<sup>(1)</sup></b>								
Continuous current with heat sink(A <sub>pk</sub> ) <sup>(2)(3)</sup>	2.1	4.2	8.4	4.2	8.4	16.8	12.6	25.2
Continuous current without heat sink(A <sub>pk</sub> ) <sup>(2)(3)</sup>	1.4	2.8	5.6	2.8	5.6	11.2	8.4	16.8
Peak current <sup>(2)(3)</sup>	6.7	13.4	26.8	13.3	26.6	53.2	40.0	80.0
Peak current in linear range(N)	3.0	6.0	12.0	6.0	12.0	24.0	18.0	36.0
Force constant(N/A <sub>pk</sub> ) <sup>(2)</sup>	94.4	47.2	23.6	94.4	47.2	23.6	47.2	23.6
Back EMF constant(V/m/s) <sup>(2)</sup>	104.0	52.0	26.0	104.0	52.0	26.0	52.0	26.0
Resistance (Ohms) <sup>(2)</sup>	19.2	4.8	1.2	9.6	2.4	0.6	1.6	0.4
Inductance(mH) <sup>(2)</sup>	200.00	50.00	10.32	100.00	25.00	5.16	16.70	3.44
Time constant(ms) <sup>(2)</sup>	10.4	10.4	8.6	10.4	10.4	8.6	10.4	8.6
Thermal resistant with heat sink(°C/W) <sup>(1)(2)</sup>	0.9			0.4			0.3	
Thermal resistant without heat sink(°C/W) <sup>(2)(3)</sup>	1.9			1.0			0.6	
Motor constant(N/√W) <sup>(2)</sup>	21.5			30.5			37.3	

(1) Value applies to the static sinusoidal drive, under specific heat sink and temperatures from 25°C to 110 °C. Actual performance depends on heat sink configuration, system cooling conditions and the ambient temperature.

(2) The tolerance of all performance and electrical specification is ±10%.

(3) The value applies to the static sinusoidal drive at temperatures from 25°C up to 110°C, without heat sink.

(4) The above "without heat sink" figure assumes a working condition of 1atm a 25°C ambient temperature, with the stationary linear motor not in contact with any other objects, relying only on air convection for cooling. As all heat conductive objects in direct contact with the linear motor, including the slide plate, linear guide and base, can be considered a type of heat sink, the "with heat sink" figure should be taken as the primary reference for actual application design.

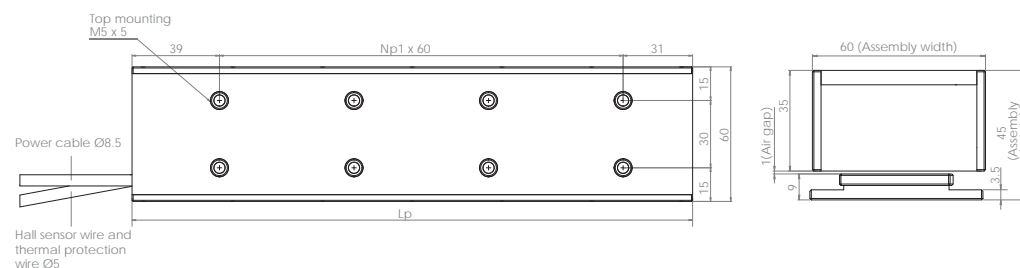

## LM-MB-60 Magnetic Way

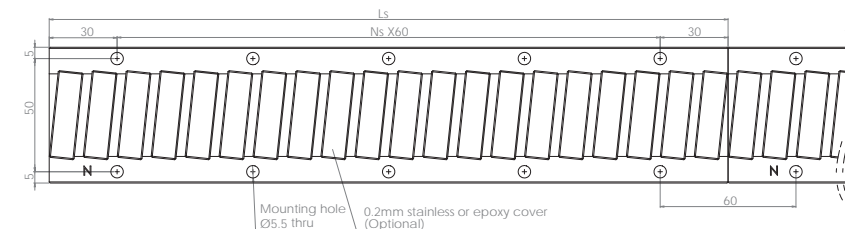

### OUTPUT CABLE ( All cable standard length is 400 mm)

Motor Wire Table			Hall Sensor Wire Table and Thermal Protection Wire Table					
Pin Number	Function	Cross section	Color	Function	Cable Dia.	Color	Function	Cable Dia.
White (1)	U phase	1.5 mm <sup>2</sup>	Pink	Hall A U phase	0.14 mm <sup>2</sup>	Brown	Thermal sensor	0.14 mm <sup>2</sup>
Yellow (2)	V phase	1.5 mm <sup>2</sup>	Yellow	Hall B V phase	0.14 mm <sup>2</sup>	Blue		
Brown (3)	W phase	1.5 mm <sup>2</sup>	Green	Hall C W phase	0.14 mm <sup>2</sup>		Shielding	
Green	PE + shielding	1.5 mm <sup>2</sup>	Grey	Hall IC + 5V	0.14 mm <sup>2</sup>			
			White	GND	0.14 mm <sup>2</sup>			

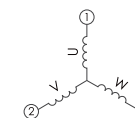

### LM-CB-60 Coil Assembly

	Np1	Lp
LM-CB2-60	1	130
LM-CB4-60	3	250
LM-CB6-60	5	370

### LM-MB-60 Magnetic Way

	Ns	Ls
LM-MB0-60	1	120
LM-MB1-60	4	300
LM-MB2-60	7	480



LM-CB-80 series  
Linear Motion Technology

## Current VS Force.

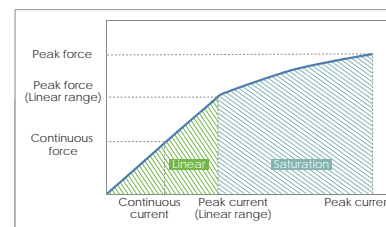

When the motor is operating in its linear sphere, its thrust output is directly proportional to the input current while measuring at a constant value. When operating in the saturation sphere, thrust output is not directly proportional to the input current due to magnetic saturation, resulting in a lower thrust output increase.

## LM-CB-80 Coil Assembly

## LM-CB-80 Coil Assembly Model

Coil Assembly Model	LM-CB2-80		LM-CB4-80		LM-CB6-80	
	P	D	P	D	P	D
Winding code						
Performance <sup>(1)</sup>						
Peak force(N) <sup>(2)(3)</sup>	848.7		1697.4		2552.5	
Continuous force with heat sink(N) <sup>(1)(2)</sup>	301.3		602.6		904.0	
Continuous force without heat sink(N) <sup>(2)(3)</sup>	200.9		401.8		602.6	
Peak force in linear range(N)	430.5		860.9		1291.4	
Attraction force(N)	958		1915		2873	
Peak power(W) <sup>(2)</sup>	1167		2335		3520	
Continuous power(W) <sup>(1)(2)</sup>	116.4		232.8		349.3	
Mechanical						
Coil assembly length(mm)	130		250		370	
Coil assembly weight(kg) <sup>(2)</sup>	2.4		4.7		6.9	
Magnetic way weight(kg/m) <sup>(2)</sup>	4.6		4.6		4.6	
Pole pitch(mm)	30		30		30	
Electrical <sup>(1)</sup>						
Continuous current with heat sink(A <sub>pk</sub> ) <sup>(1)(2)</sup>	4.2	8.4	8.4	16.8	12.6	25.2
Continuous current without heat sink(A <sub>pk</sub> ) <sup>(2)(3)</sup>	2.8	5.6	5.6	11.2	8.4	16.8
Peak current <sup>(2)(3)</sup>	13.3	26.6	26.6	53.3	40.0	80.0
Peak current in linear range(N)	6.0	12.0	12.0	24.0	18.0	36.0
Force constant(N/A <sub>pk</sub> ) <sup>(2)</sup>	71.7	35.9	71.7	35.9	71.7	35.9
Back EMF constant(V/m/s) <sup>(2)</sup>	79.0	39.5	79.0	39.5	79.0	39.5
Resistance (Ohms) <sup>(2)</sup>	6.6	1.7	3.3	0.8	2.2	0.6
Inductance(mH) <sup>(2)</sup>	68.75	14.28	34.38	6.72	22.92	5.04
Time constant(ms) <sup>(2)</sup>	10.4	8.4	10.4	8.4	10.4	8.4
Thermal resistant with heat sink(°C/W) <sup>(1)(2)</sup>	0.6		0.3		0.2	
Thermal resistant without heat sink(°C/W) <sup>(2)(3)</sup>	1.4		0.7		0.5	
Motor constant(N/√W) <sup>(2)</sup>	27.9		39.5		48.4	

(1) Value applies to the static sinusoidal drive, under specific heat sink and temperatures from 25°C to 110 °C. Actual performance depends on heat sink configuration, system cooling conditions and the ambient temperature.

(2) The tolerance of all performance and electrical specification is ±10%.

(3) The value applies to the static sinusoidal drive at temperatures from 25°C up to 110°C, without heat sink.

(4) The above "without heat sink" figure assumes a working condition of 1atm a 25°C ambient temperature, with the stationary linear motor not in contact with any other objects, relying only on air convection for cooling. As all heat conductive objects in direct contact with the linear motor, including the slide plate, linear guide and base, can be considered a type of heat sink, the "with heat sink" figure should be taken as the primary reference for actual application design.

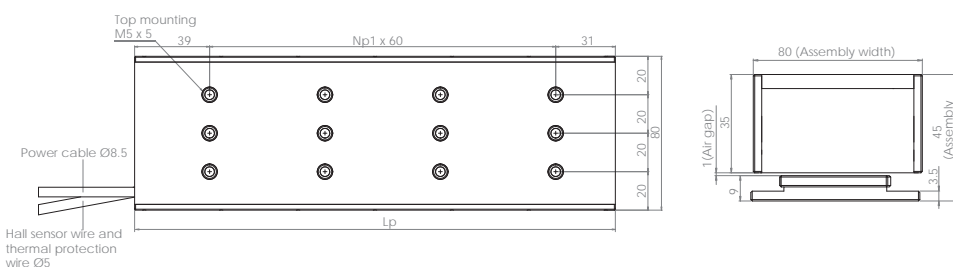

## LM-MB-80 Magnetic Way

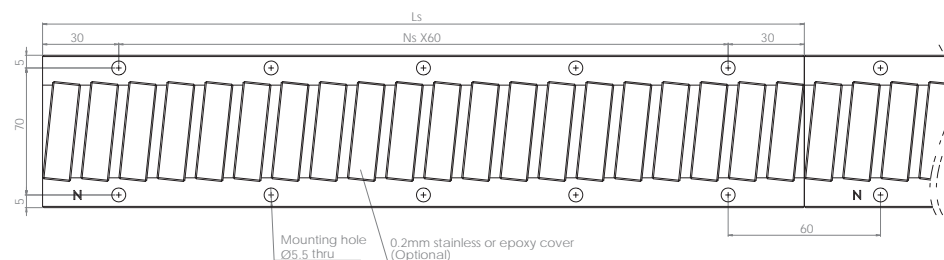

## OUTPUT CABLE (All cable standard length is 400 mm)

Motor Wire Table			Hall Sensor Wire Table and Thermal Protection Wire Table					
Pin Number	Function	Cross section	Color	Function	Cable Dia.	Color	Function	Cable Dia.
White (1)	U phase	1.5 mm <sup>2</sup>	Pink	Hall A U phase	0.14 mm <sup>2</sup>	Brown	Thermal sensor	0.14 mm <sup>2</sup>
Yellow (2)	V phase	1.5 mm <sup>2</sup>	Yellow	Hall B V phase	0.14 mm <sup>2</sup>	Blue		
Brown (3)	W phase	1.5 mm <sup>2</sup>	Green	Hall C W phase	0.14 mm <sup>2</sup>		Shielding	
Green	PE + shielding	1.5 mm <sup>2</sup>	Grey	Hall IC + 5V	0.14 mm <sup>2</sup>			
			White	GND	0.14 mm <sup>2</sup>			

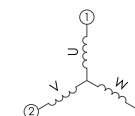

## LM-CB-80 Coil Assembly

	Np1	Lp
LM-CB2-80	1	130
LM-CB4-80	3	250
LM-CB6-80	5	370

## LM-MB-80 Magnetic Way

	Ns	Ls
LM-MB0-80	1	120
LM-MB1-80	4	300
LM-MB2-80	7	480





LM-CC-64 series  
Linear Motion Technology

## Current VS Force.

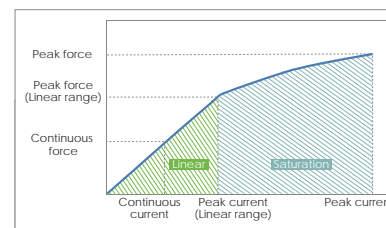

When the motor is operating in its linear sphere, its thrust output is directly proportional to the input current while measuring at a constant value. When operating in the saturation sphere, thrust output is not directly proportional to the input current due to magnetic saturation, resulting in a lower thrust output increase.

## LM-CC-64 Coil Assembly

## LM-CC-64 Coil Assembly Model

Coil Assembly Model	LM-CC2-64		LM-CC4-64		LM-CC6-64	
	P	D	P	D	P	D
Winding code						
Performance <sup>(1)</sup>						
Peak force(N) <sup>(2)(3)</sup>	592		1185		1777	
Continuous force with heat sink(N) <sup>(1)(2)</sup>	258.5		517.0		775.4	
Continuous force without heat sink(N) <sup>(2)(3)</sup>	143.6		287.2		430.8	
Peak force in linear range(N)	287.2		574.4		861.6	
Attraction force(N)	590		1180		1770	
Peak power(W) <sup>(2)</sup>	1755		3510		5265	
Continuous power(W) <sup>(1)(2)</sup>	101.1		202.2		303.3	
Mechanical						
Coil assembly length(mm)	162		314		466	
Coil assembly weight(kg) <sup>(2)</sup>	2.3		4.5		6.6	
Magnetic way weight(kg/m) <sup>(2)</sup>	3.6		3.6		3.6	
Pole pitch(mm)	38		38		38	
Electrical <sup>(1)</sup>						
Continuous current with heat sink(A <sub>pk</sub> ) <sup>(1)(2)</sup>	3.6	7.2	7.2	14.4	10.8	21.6
Continuous current without heat sink(A <sub>pk</sub> ) <sup>(2)(3)</sup>	2.0	4.0	4.0	8.0	6.0	12.0
Peak current <sup>(2)(3)</sup>	15.0	30.0	30.0	60.0	45.0	90.0
Peak current in linear range(N)	4.0	8.0	8.0	16.0	12.0	24.0
Force constant(N/A <sub>pk</sub> ) <sup>(2)</sup>	71.8	35.9	71.8	35.9	71.8	35.9
Back EMF constant(V/m/s) <sup>(2)</sup>	87.5	43.8	87.5	43.8	87.5	43.8
Resistance(Ohms) <sup>(2)</sup>	7.8	2.0	3.9	1.0	2.6	0.7
Inductance(mH) <sup>(2)</sup>	119.20	24.00	59.60	12.00	39.70	8.40
Time constant(ms) <sup>(2)</sup>	15	12	15	12	15	12
Thermal resistant with heat sink(°C/W) <sup>(1)(2)</sup>		0.7		0.4		0.2
Thermal resistant without heat sink(°C/W) <sup>(2)(3)</sup>		2.9		1.4		1.0
Motor constant(N/√W) <sup>(2)</sup>		25.7		36.4		44.5

(1) Value applies to the static sinusoidal drive, under specific heat sink and temperatures from 25°C to 110°C. Actual performance depends on heat sink configuration, system cooling conditions and the ambient temperature.

(2) The tolerance of all performance and electrical specification is ±10%.

(3) The value applies to the static sinusoidal drive at temperatures from 25°C up to 110°C, without heat sink.

(4) The above "without heat sink" figure assumes a working condition of 1atm a 25°C ambient temperature, with the stationary linear motor not in contact with any other objects, relying only on air convection for cooling. As all heat conductive objects in direct contact with the linear motor, including the slide plate, linear guide and base, can be considered a type of heat sink, the "with heat sink" figure should be taken as the primary reference for actual application design.

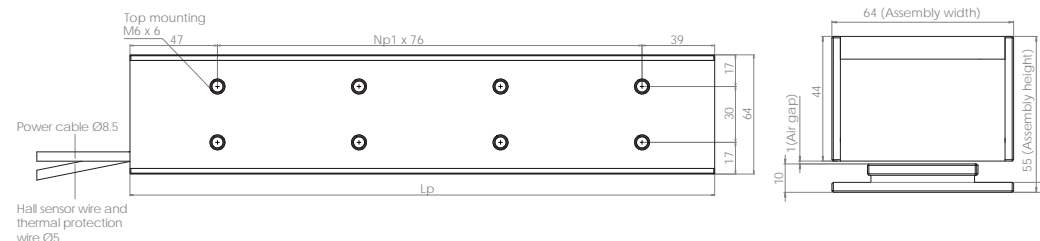

## LM-MC-64 Magnetic Way

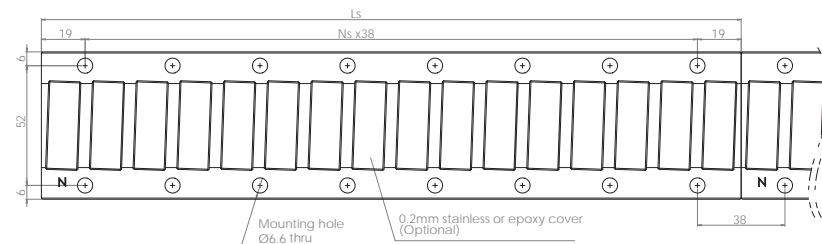

## OUTPUT CABLE ( All cable standard length is 400 mm)

Motor Wire Table			Hall Sensor Wire Table and Thermal Protection Wire Table					
Pin Number	Function	Cross section	Color	Function	Cable Dia.	Color	Function	Cable Dia.
White (1)	U phase	1.5 mm <sup>2</sup>	Pink	Hall A U phase	0.14 mm <sup>2</sup>	Brown	Thermal sensor	0.14 mm <sup>2</sup>
Yellow (2)	V phase	1.5 mm <sup>2</sup>	Yellow	Hall B V phase	0.14 mm <sup>2</sup>	Blue		
Brown (3)	W phase	1.5 mm <sup>2</sup>	Green	Hall C W phase	0.14 mm <sup>2</sup>		Shielding	
Green	PE + shielding	1.5 mm <sup>2</sup>	Grey	Hall IC + 5V	0.14 mm <sup>2</sup>			
			White	GND	0.14 mm <sup>2</sup>			

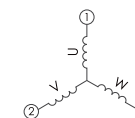

## LM-CC-64 Coil Assembly

	Np1	Lp
LM-CC2-64	1	162
LM-CC4-64	3	314
LM-CC6-64	5	466

## LM-MC-64 Magnetic Way

	Ns	Ls
LM-MC0-64	2	114
LM-MC1-64	7	304
LM-MC2-64	11	456



LM-CC-84 series  
Linear Motion Technology

### Current VS Force.

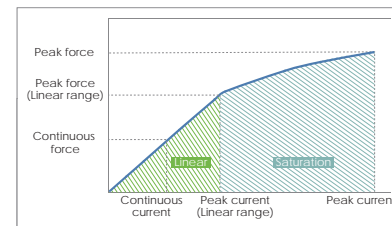

When the motor is operating in its linear sphere, its thrust output is directly proportional to the input current while measuring at a constant value. When operating in the saturation sphere, thrust output is not directly proportional to the input current due to magnetic saturation, resulting in a lower thrust output increase.

### LM-CC-84 Coil Assembly

### LM-CC-84 Coil Assembly Model

Coil Assembly Model	LM-CC2-84		LM-CC4-84		LM-CC6-84	
	P	D	P	D	P	D
Winding code						
Performance <sup>(1)</sup>						
Peak force(N) <sup>(2)(3)</sup>	900.9		1800		2700	
Continuous force with heat sink(N) <sup>(1)(2)</sup>	392.9		785.8		1178.7	
Continuous force without heat sink(N) <sup>(2)(3)</sup>	218.2		436.4		654.6	
Peak force in linear range(N)	436.5		873.1		1309.6	
Attraction force(N)	897		1794		2690	
Peak power(W) <sup>(2)</sup>	2295		4590		6885	
Continuous power(W) <sup>(1)(2)</sup>	132.2		264.4		396.6	
Mechanical						
Coil assembly length(mm)	162		314		466	
Coil assembly weight(kg) <sup>(2)</sup>	3.5		6.8		10.1	
Magnetic way weight(kg/m) <sup>(2)</sup>	5.5		5.5		5.5	
Pole pitch(mm)	38		38		38	
Electrical <sup>(4)</sup>						
Continuous current with heat sink(A <sub>pk</sub> ) <sup>(2)(3)</sup>	3.6	7.2	7.2	14.4	10.8	20.5
Continuous current without heat sink(A <sub>pk</sub> ) <sup>(2)(3)</sup>	2.0	4.0	4.0	8.0	6.0	12.0
Peak current <sup>(2)(3)</sup>	15.0	30.0	30.0	60.0	45.0	90.0
Peak current in linear range(N)	4.0	8.0	8.0	16.0	12.0	24.0
Force constant(N/A <sub>pk</sub> ) <sup>(2)</sup>	109.1	54.6	109.1	54.6	109.1	54.6
Back EMF constant(V/m/s) <sup>(2)</sup>	133.0	66.5	133.0	66.5	133.0	66.5
Resistance (Ohms) <sup>(2)</sup>	10.2	2.6	5.1	1.3	3.4	0.9
Inductance(mH) <sup>(2)</sup>	155.90	31.20	77.90	15.60	52.00	10.80
Time constant(ms) <sup>(2)</sup>	15	12	15	12	15	12
Thermal resistant with heat sink(°C/W) <sup>(1)(2)</sup>		0.6		0.3		0.2
Thermal resistant without heat sink(°C/W) <sup>(2)(3)</sup>		2.2		1.1		0.7
Motor constant(N/√W) <sup>(2)</sup>		34.2		48.3		59.2

(1) Value applies to the static sinusoidal drive, under specific heat sink and temperatures from 25°C to 110°C. Actual performance depends on heat sink configuration, system cooling conditions and the ambient temperature.

(2) The tolerance of all performance and electrical specification is ±10%.

(3) The value applies to the static sinusoidal drive at temperatures from 25°C up to 110°C, without heat sink.

(4) The above "without heat sink" figure assumes a working condition of 1atm a 25°C ambient temperature, with the stationary linear motor not in contact with any other objects, relying only on air convection for cooling. As all heat conductive objects in direct contact with the linear motor, including the slide plate, linear guide and base, can be considered a type of heat sink, the "with heat sink" figure should be taken as the primary reference for actual application design.

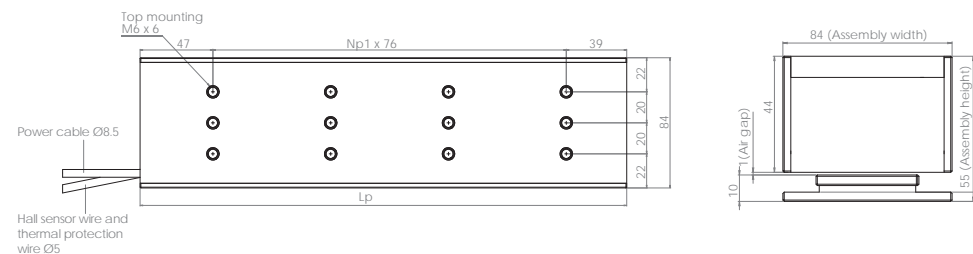

### LM-MC-84 Magnetic Way

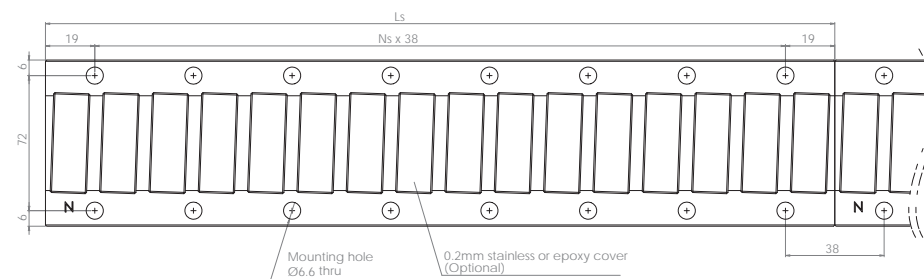

### OUTPUT CABLE ( All cable standard length is 400 mm)

Motor Wire Table			Hall Sensor Wire Table and Thermal Protection Wire Table					
Pin Number	Function	Cross section	Color	Function	Cable Dia.	Color	Function	Cable Dia.
White (1)	U phase	1.5 mm <sup>2</sup>	Pink	Hall A U phase	0.14 mm <sup>2</sup>	Brown	Thermal sensor	0.14 mm <sup>2</sup>
Yellow (2)	V phase	1.5 mm <sup>2</sup>	Yellow	Hall B V phase	0.14 mm <sup>2</sup>	Blue		
Brown (3)	W phase	1.5 mm <sup>2</sup>	Green	Hall C W phase	0.14 mm <sup>2</sup>		Shielding	
Green	PE + shielding	1.5 mm <sup>2</sup>	Grey	Hall IC + 5V	0.14 mm <sup>2</sup>			
			White	GND	0.14 mm <sup>2</sup>			

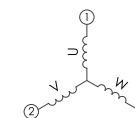

### LM-CC-84 Coil Assembly

	Np1	Lp
LM-CC2-84	1	162
LM-CC4-84	3	314
LM-CC6-84	5	466

### LM-MC-84 Magnetic Way

	Ns	Ls
LM-MC0-84	2	114
LM-MC1-84	7	304
LM-MC2-84	11	456





LM-CC-124 series  
Linear Motion Technology

### Current VS Force.

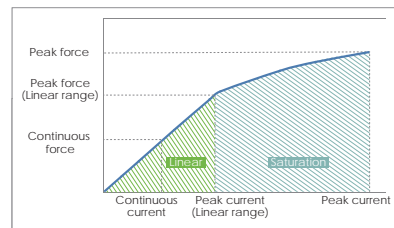

When the motor is operating in its linear sphere, its thrust output is directly proportional to the input current while measuring at a constant value. When operating in the saturation sphere, thrust output is not directly proportional to the input current due to magnetic saturation, resulting in a lower thrust output increase.

### LM-CC-124 Coil Assembly

### LM-CC-124 Coil Assembly Model

Coil Assembly Model	LM-CC2-124		LM-CC4-124		LM-CC6-124	
	P	D	P	D	P	D
Winding code						
Performance <sup>(4)</sup>						
Peak force(N) <sup>(2)(3)</sup>	1446		2881		4327	
Continuous force with heat sink(N) <sup>(1)(2)</sup>	628.6		1257.2		1885.9	
Continuous force without heat sink(N) <sup>(2)(3)</sup>	349.2		698.4		1047.7	
Peak force in linear range(N)	735.2		1470.5		2205.7	
Attraction force(N)	1510		3021		4531	
Peak power(W) <sup>(2)</sup>	3067		6092		9159	
Continuous power(W) <sup>(1)(2)</sup>	175.4		350.9		526.3	
Mechanical						
Coil assembly length(mm)	162		314		466	
Coil assembly weight(kg) <sup>(2)</sup>	5.9		11.4		16.9	
Magnetic way weight(kg/m) <sup>(2)</sup>	9.2		9.2		9.2	
Pole pitch(mm)	38		38		38	
Electrical <sup>(4)</sup>						
Continuous current with heat sink(A <sub>pk</sub> ) <sup>(2)(3)</sup>	3.4	6.8	6.8	13.7	10.3	20.5
Continuous current without heat sink(A <sub>pk</sub> ) <sup>(2)(3)</sup>	1.9	3.8	3.8	7.6	5.7	11.4
Peak current <sup>(2)(3)</sup>	14.3	28.5	28.5	57.0	42.8	85.5
Peak current in linear range(N)	4.0	8.0	8.0	16.0	12.0	24.0
Force constant(N/A <sub>pk</sub> ) <sup>(2)</sup>	183.8	91.9	183.8	91.9	183.8	91.9
Back EMF constant(V/m/s) <sup>(2)</sup>	224.0	112.0	224.0	112.0	224.0	112.0
Resistance (Ohms) <sup>(2)</sup>	15	3.8	7.5	1.9	5.0	1.3
Inductance(mH) <sup>(2)</sup>	229.20	46.36	114.60	28.18	76.40	15.86
Time constant(ms) <sup>(2)</sup>	15	12.2	15	12.2	15	12.2
Thermal resistant with heat sink(°C/W) <sup>(1)(2)</sup>	0.4		0.2		0.1	
Thermal resistant without heat sink(°C/W) <sup>(2)(3)</sup>	1.7		0.8		0.6	
Motor constant(N/√W) <sup>(2)</sup>	47.5		67.1		82.2	

(1) Value applies to the static sinusoidal drive, under specific heat sink and temperatures from 25°C to 110 °C. Actual performance depends on heat sink configuration, system cooling conditions and the ambient temperature.  
 (2) The tolerance of all performance and electrical specification is ±10%.  
 (3) The value applies to the static sinusoidal drive at temperatures from 25°C up to 110°C, without heat sink.  
 (4) The above "without heat sink" figure assumes a working condition of 1atm a 25°C ambient temperature, with the stationary linear motor not in contact with any other objects, relying only on air convection for cooling. As all heat conductive objects in direct contact with the linear motor, including the slide plate, linear guide and base, can be considered a type of heat sink, the "with heat sink" figure should be taken as the primary reference for actual application design.

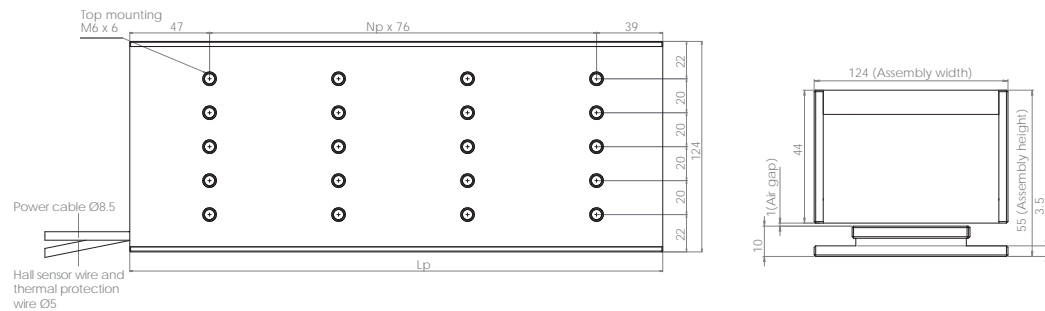

### LM-MC-124 Magnetic Way

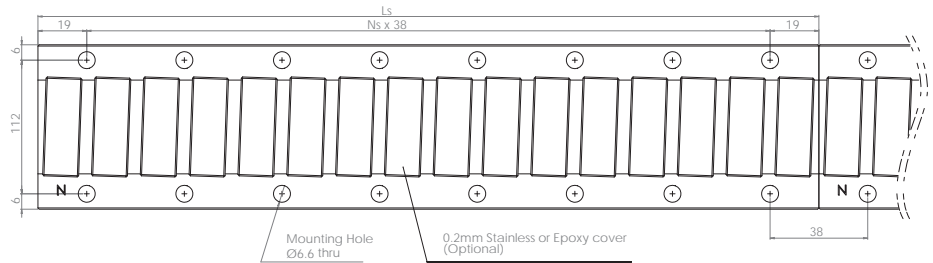

### LM-CC-124 Coil Assembly

	Np1	Lp
LM-CC2-124	1	162
LM-CC4-124	3	314
LM-CC6-124	5	466

### LM-MC-124 Magnetic Way

	Ns	Ls
LM-MC0-124	2	114
LM-MC1-124	7	304
LM-MC2-124	11	456

### OUTPUT CABLE ( All cable standard length is 400 mm)

Motor Wire Table			Hall Sensor Wire Table and Thermal Protection Wire Table					
Pin Number	Function	Cross section	Color	Function	Cable Dia.	Color	Function	Cable Dia.
White (1)	U phase	1.5 mm <sup>2</sup>	Pink	Hall A U phase	0.14 mm <sup>2</sup>	Brown	Thermal sensor	0.14 mm <sup>2</sup>
Yellow (2)	V phase	1.5 mm <sup>2</sup>	Yellow	Hall B V phase	0.14 mm <sup>2</sup>	Blue		
Brown (3)	W phase	1.5 mm <sup>2</sup>	Green	Hall C W phase	0.14 mm <sup>2</sup>		Shielding	
Green	PE + shielding	1.5 mm <sup>2</sup>	Grey	Hall IC + 5V	0.14 mm <sup>2</sup>			
			White	GND	0.14 mm <sup>2</sup>			

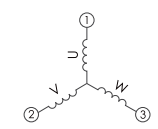

## Sizing Example

Condition 1: Motion profile containing cruising section

Driver maximum output voltage : 300Vdc

Driver continuous output current : 2A

Driver peak output current : 5A

Max. velocity :  $V_{max} = 2$  [m/s]

Cruising time :  $t_2 = 3$  [s]

Load mass :  $m = 5$  [kg]

Decelerating time :  $t_3 = 0.2$  [s]

Acceleration :  $a = 10$  [m/s<sup>2</sup>]

Dwell time :  $t_4 = 2$  [s]

Accelerating time :  $t_1 = 0.2$  [s]

Friction Force :  $f = 5$  [N]

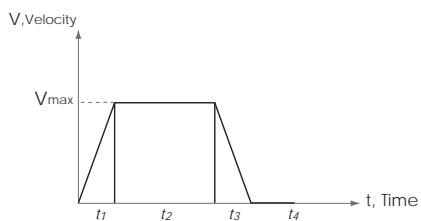

Symbol	Parameter	Metric	Imperial
$t_1$	Accelerating time	s	s
$t_2$	Cruising time	s	s
$t_3$	Decelerating time	s	s
$t_4$	Dwell time	s	s
$V_{max}$	Max. velocity	m/S	in/S

### Step1: Thrust force calculation

$$F_1 = ma + f = 5 \times 10 + 5 = 55 \text{ [N]}$$

$$F_2 = f = 5 \text{ [N]}$$

$$F_3 = ma - f = 5 \times 10 - 5 = 45 \text{ [N]}$$

$$F_4 = 0 \text{ [N]}$$

$$F_{rms} = \sqrt{\frac{F_1^2 \times t_1 + F_2^2 \times t_2 + F_3^2 \times t_3 + F_4^2 \times t_4}{t_1 + t_2 + t_3 + t_4}}$$

$$= \sqrt{\frac{55^2 \times 0.2 + 5^2 \times 3 + 45^2 \times 0.2 + 0}{0.2 + 3 + 0.2 + 2}} = 14.2 \text{ [N]}$$

$$F_{max} = F_1 = 55 \text{ [N]}$$

$$\text{Safety factor} = 1.5$$

Motor required peak force needs to be greater than

$$F_{max} \times 1.5 = 55 \times 1.5 = 82.5 \text{ [N]}$$

Motor required continuous force needs to be greater than

$$F_{rms} \times 1.5 = 14.2 \times 1.5 = 21.3 \text{ [N]}$$

Hence choose LM-PA-X2

(Peak Force= 123.8[N], Continuous force = 31[N])

### Step2: Wiring selection

If W1 model is chosen

$$I_{rms} = F_{rms} / K_f = 21.3 / 17.2 = 1.24 \text{ [A]}$$

$$I_{max} = F_{max} / k_f = 82.5 / 17.2 = 4.8 \text{ [A]}$$

$$\text{Required voltage} = V_{max} \times K_e + I_{max} \times R$$

$$= 2 \times 20 + 4.8 \times 17 = 121.6 \text{ [V]}$$

Take safety factor = 1.3

$$\text{Required supply voltage } 121.6 \times 1.3 = 158.1 \text{ [V]}$$

Driver :

Continuous output current 2A > 1.24A

Peak output current 5A > 4.8A

Max. output voltage 300V > 158.1V

W1 model matches requirements.

LM-PA-X2-W1 will be applicable.

Condition 2 : Motion Profile without cruising velocity section

Driver maximum output voltage : 80Vdc

Driver continuous output current : 2A

Driver peak output current : 4A

Load mass : 5 [kg]

Moving Time :  $T = 1$  [s]

Stroke :  $S = 1$  [m]

Friction Force :  $f = 5$  [N]

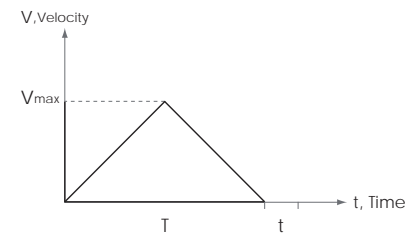

Symbol	Parameter	Metric	Imperial
$t$	Stop time	s	s
$T$	Moving time	s	s
$V_{max}$	Max. velocity	m/s	in/s
$a$	Acceleration	m/s <sup>2</sup>	in/s <sup>2</sup>
$s$	Stroke	m	in

### Step1: Thrust force calculation

$$a = 4S/T^2 = 4 \times 1/1 = 4 \text{ m/s}^2$$

$$F_1 = ma + f = 5 \times 4 + 5 = 25 \text{ [N]}$$

$$F_2 = ma - f = 5 \times 4 - 5 = 15 \text{ [N]}$$

$$F_3 = 0 \text{ [N]}$$

$$F_{rms} = \sqrt{\frac{F_1^2 \times t_1 + F_2^2 \times t_2 + F_3^2 \times t_3}{t_1 + t_2 + t_3}}$$

$$F_{rms} = \sqrt{\frac{25^2 \times 0.5 + 15^2 \times 0.5 + 0}{0.5 + 0.5 + 0.2}} = 18.8 \text{ [N]}$$

$$F_{max} = F_1 = 25 \text{ [N]}$$

$$\text{Safety factor} = 1.5$$

Motor required peak force needs to be greater than

$$F_{max} \times 1.5 = 25 \times 1.5 = 37.5 \text{ [N]}$$

Motor required continuous force needs to be greater than

$$F_{rms} \times 1.5 = 18.8 \times 1.5 = 28.2 \text{ [N]}$$

Hence choose LM-PA-X4

(Peak Force= 151.4[N], Continuous force = 37.8[N])

### Step2: Wiring selection

If W1 model is chosen

$$I_{rms} = F_{rms} / K_f = 18.8 / 34.4 = 0.55 \text{ [A]}$$

$$I_{max} = F_{max} / K_f = 25 / 34.4 = 0.73 \text{ [A]}$$

$$V_{max} = T/2 \times a = 1/2 \times 4 = 2 \text{ [m/s]}$$

$$\text{Required voltage} = V_{max} \times K_e + I_{max} \times R$$

$$= 2 \times 40 + 0.73 \times 34 = 104.8 \text{ [V]}$$

Take safety factor = 1.3

$$\text{Required supply voltage } 104.8 \times 1.3 = 136.2 \text{ [V]}$$

Driver :

Continuous output current 2A > 0.55A

Peak output current 4A > 0.73A

Max. output voltage 80V < 136.2V

Max. velocity cannot be reached with W1.

If W2 model is chosen

$$I_{rms} = F_{rms} / K_f = 18.8/17.2 = 1.1 \text{ [A]}$$

$$I_{max} = F_{max} / K_f = 25/17.2 = 1.45 \text{ [A]}$$

$$\text{Required voltage} = V_{max} \times K_e + I_{max} \times R$$

$$= 2 \times 20 + 1.45 \times 8.5 = 52.3 \text{ [V]}$$

Take safety factor = 1.3

$$\text{Required supply voltage } 52.3 \times 1.3 = 68 \text{ [V]}$$

Driver :

Continuous output current 2A > 1.1A

Peak output current 4A > 1.45A

Max. output voltage 80V > 68V

W2 model matches requirements.

LM-PA-X4-W2 will be applicable.

Note: For other calculation constraints or special requirements please contact [cpc](#).

Sizing Form

Customer Name /	Filling Date (DD/MM/YEAR) /
Contact Person /	Telephone /
E-mail /	Fax /

1. Point-to-point motion without constant velocity

Property: Specific travel distance in specific time  
Application: Pick and place, carriage etc.

a. Known Motion Condition	
(1) Load mass	kg
(2) Effective stroke	m
(3) Moving time	s
(4) Dwell time	s

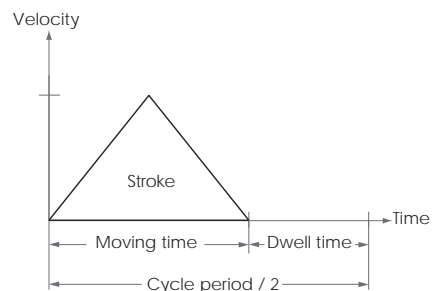

b. Driver Condition	
(1) Max. output voltage	V
(2) Continuous current	A
(3) Peak current	A

c. Encoder	
(1) <input type="checkbox"/> Analog <input type="checkbox"/> Digital	
(2) Resolution	μm

f. Motion Direction	
(1) <input type="checkbox"/> Horizontal	
(2) <input type="checkbox"/> Vertical	
(3) <input type="checkbox"/> Tilt _____ degrees	

d. Working Environment	
(1) <input type="checkbox"/> Room temperature	
(2) <input type="checkbox"/> Constant temperature _____°C	
(3) <input type="checkbox"/> Vacuum _____ Torr	
(4) <input type="checkbox"/> Clean room _____ level	

g. Installation Method	
(1) <input type="checkbox"/> Lying flat	
(2) <input type="checkbox"/> Vertically standing	
(3) <input type="checkbox"/> Wall mount	

e. Motion Precision	
(1) Positioning accuracy	μm
(2) Repetitive accuracy	μm

h. Space Restrictions	
(1) <input type="checkbox"/> None	
(2) <input type="checkbox"/> Yes _____mm x _____mm x _____mm	

Sizing Form

Customer Name /	Filling Date (DD/MM/YEAR) /
Contact Person /	Telephone /
E-mail /	Fax /

2. Point-to-Point Motion without constant velocity

Property: Specific travel distance in specific time  
Application: Pick and place, carriage etc.

a. Known Motion Condition	
(1) Load mass	kg
(2) Effective stroke	m
(3) Frequency	Hz
(4) Dwell time	s

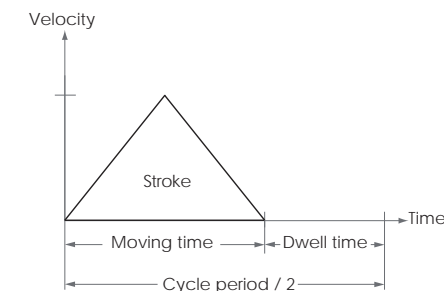

b. Driver Condition	
(1) Max. output voltage	V
(2) Continuous current	A
(3) Peak current	A

c. Encoder	
(1) <input type="checkbox"/> Analog <input type="checkbox"/> Digital	
(2) Resolution	μm

f. Motion Direction	
(1) <input type="checkbox"/> Horizontal	
(2) <input type="checkbox"/> Vertical	
(3) <input type="checkbox"/> Tilt _____ Degrees	

d. Working Environment	
(1) <input type="checkbox"/> Room temperature	
(2) <input type="checkbox"/> Constant temperature _____°C	
(3) <input type="checkbox"/> Vacuum _____ Torr	
(4) <input type="checkbox"/> Clean room _____ level	

g. Installation Method	
(1) <input type="checkbox"/> Lying flat	
(2) <input type="checkbox"/> Vertically standing	
(3) <input type="checkbox"/> Wall mount	

e. Motion Precision	
(1) Positioning accuracy	μm
(2) Repetitive accuracy	μm

h. Space Restrictions	
(1) <input type="checkbox"/> None	
(2) <input type="checkbox"/> Yes _____mm x _____mm x _____mm	

Sizing Form

Customer Name /	Filling Date (DD/MM/YEAR) /
Contact Person /	Telephone /
E-mail /	Fax /

3. Point-to-Point Motion without constant velocity

Property: Specific travel distance in specific time  
Application: Pick and place, carriage etc.

a. Known Motion Condition	
(1) Load mass	kg
(2) Effective stroke	m
(3) Acceleration	m/s <sup>2</sup>
(4) Dwell time	s

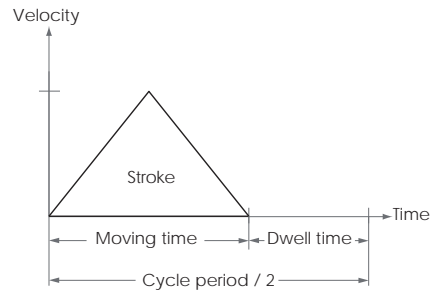

b. Driver Condition	
(1) Max. output voltage	V
(2) Continuous current	A
(3) Peak current	A

c. Encoder	
(1) <input type="checkbox"/> Analog <input type="checkbox"/> Digital	
(2) Resolution	μm

f. Motion Direction	
(1) <input type="checkbox"/> Horizontal	
(2) <input type="checkbox"/> Vertical	
(3) <input type="checkbox"/> Tilt _____ degrees	

d. Working Environment	
(1) <input type="checkbox"/> Room temperature	
(2) <input type="checkbox"/> Constant temperature _____°C	
(3) <input type="checkbox"/> Vacuum _____ Torr	
(4) <input type="checkbox"/> Clean room _____ level	

g. Installation Method	
(1) <input type="checkbox"/> Lying flat	
(2) <input type="checkbox"/> Vertically standing	
(3) <input type="checkbox"/> Wall mount	

e. Motion Precision	
(1) Positioning accuracy	μm
(2) Repetitive accuracy	μm

h. Space Restrictions	
(1) <input type="checkbox"/> None	
(2) <input type="checkbox"/> Yes _____mm x _____mm x _____mm	

Sizing Form

Customer Name /	Filling Date (DD/MM/YEAR) /
Contact Person /	Telephone /
E-mail /	Fax /

4. Point-to-Point Motion with constant velocity

Property: Work performed under constant velocity  
Application: Scanning, inspection, cutting etc.

a. Motion Condition	
(1) Load mass	kg
(2) Effective stroke	m
(3) Moving time	s
(4) Dwell time	s
(5) Acceleration	m/s <sup>2</sup>

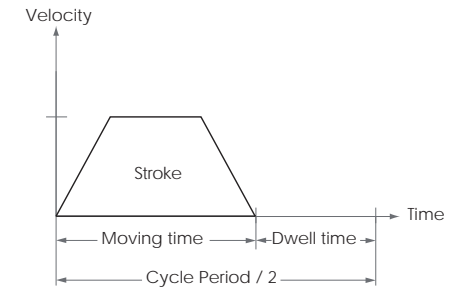

b. Driver Condition	
(1) Max. output voltage	V
(2) Continuous current	A
(3) Peak current	A

c. Encoder	
(1) <input type="checkbox"/> Analog <input type="checkbox"/> Digital	
(2) Resolution	μm

f. Motion Direction	
(1) <input type="checkbox"/> Horizontal	
(2) <input type="checkbox"/> Vertical	
(3) <input type="checkbox"/> Tilt _____ degrees	

d. Working Environment	
(1) <input type="checkbox"/> Room Temperature	
(2) <input type="checkbox"/> Constant Temperature _____°C	
(3) <input type="checkbox"/> Vacuum _____ Torr	
(4) <input type="checkbox"/> Clean room _____ level	

g. Installation Method	
(1) <input type="checkbox"/> Lying flat	
(2) <input type="checkbox"/> Vertically standing	
(3) <input type="checkbox"/> Wall mount	

e. Motion Precision	
(1) Positioning accuracy	μm
(2) Repetitive accuracy	μm

h. Space Restrictions	
(1) <input type="checkbox"/> None	
(2) <input type="checkbox"/> Yes _____mm x _____mm x _____mm	

Sizing Form

Customer Name /	Filling Date (DD/MM/YEAR) /
Contact Person /	Telephone /
E-mail /	Fax /

5. Point-to-point motion with constant velocity

Property: Work performed under constant velocity  
 Application: Scanning, inspection, cutting etc.

a. Motion Condition	
(1) Load mass	kg
(2) Effective stroke	m
(3) Max. velocity	m/s
(4) Acceleration time	s
(5) Dwell time	s

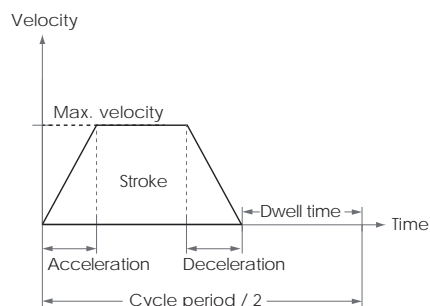

b. Driver Condition	
(1) Max. output voltage	V
(2) Continuous current	A
(3) Peak current	A

c. Encoder	
(1) <input type="checkbox"/> Analog <input type="checkbox"/> Digital	
(2) Resolution	μm

d. Working Environment	
(1) <input type="checkbox"/> Room temperature	
(2) <input type="checkbox"/> Constant temperature _____°C	
(3) <input type="checkbox"/> Vacuum _____ Torr	
(4) <input type="checkbox"/> Clean room _____ level	

e. Motion Precision	
(1) Positioning accuracy	μm
(2) Repetitive accuracy	μm

f. Motion Direction	
(1) <input type="checkbox"/> Horizontal	
(2) <input type="checkbox"/> Vertical	
(3) <input type="checkbox"/> Tilt _____ degrees	

g. Installation Method	
(1) <input type="checkbox"/> Lying flat	
(2) <input type="checkbox"/> Vertically standing	
(3) <input type="checkbox"/> Wall mount	

h. Space Restrictions	
(1) <input type="checkbox"/> None	
(2) <input type="checkbox"/> Yes _____mm x _____mm x _____mm	

Sizing Form

Customer Name /	Filling Date (DD/MM/YEAR) /
Contact Person /	Telephone /
E-mail /	Fax /

6. Point-to-Point Motion with constant velocity section

Property: Work performed under constant velocity  
 Application: Scanning, inspection, cutting etc.

a. Motion Condition	
(1) Load mass	kg
(2) Effective stroke	m
(3) Moving time	s
(4) Acceleration	m/s <sup>2</sup>
(5) Dwell time	s

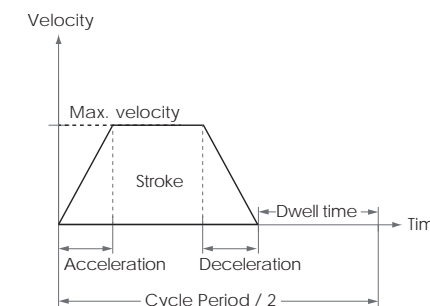

b. Driver Condition	
(1) Max. output voltage	V
(2) Continuous current	A
(3) Peak current	A

c. Encoder	
(1) <input type="checkbox"/> Analog <input type="checkbox"/> Digital	
(2) Resolution	μm

d. Working Environment	
(1) <input type="checkbox"/> Room temperature	
(2) <input type="checkbox"/> Constant temperature _____°C	
(3) <input type="checkbox"/> Vacuum _____ Torr	
(4) <input type="checkbox"/> Clean room _____ level	

e. Motion Precision	
(1) Positioning accuracy	μm
(2) Repetitive accuracy	μm

f. Motion Direction	
(1) <input type="checkbox"/> Horizontal	
(2) <input type="checkbox"/> Vertical	
(3) <input type="checkbox"/> Tilt _____ degrees	

g. Installation Method	
(1) <input type="checkbox"/> Lying flat	
(2) <input type="checkbox"/> Vertically standing	
(3) <input type="checkbox"/> Wall mount	

h. Space Restrictions	
(1) <input type="checkbox"/> None	
(2) <input type="checkbox"/> Yes _____mm x _____mm x _____mm	