



# ECG CNC Cylindrical Grinder Series



2017 The 16th  
excellent hand Award



2017 The 14th  
National brand  
Award



2017 The 18th  
Top 10 innovative research  
and development



2017 The 18th  
Top 10 business  
pioneer model



ISO 9001: 2015



Machinery  
Directive  
Number 1674



IT'S VERY WELL  
MADE IN TAIWAN

[www.equiptop.com.tw](http://www.equiptop.com.tw)

EXCELLENT · FEATURES · PROVIDE · VALUE



#### Patent Items

##### Obtained national patents for grinder:

- Longitudinal straight movement construction of surface grinder.
- Timing belt straight drive system.
- Dual motors, positioning and feeding structure.

##### More national patents:

- Timing belt drive system for the table of surface grinders.
- Roughing and micro table speed control construction.
- New travel direction change for surface grinding.

##### Obtained US patents:

- Surface grinding table reverse construction.
- Belt drive construction for surface grinding table.

##### Obtain German patent:

- Safety handwheel system.

##### Honored with national patents:

- Multi-formed grinder.
- Dust collect / coolant and dust unit.

##### ■ NC & CNC multiple formed molds.

- One wire of table multiple transmission.
- Motor fan cooling structure.
- Simultaneous processer.
- Vacuum wind turbine structure for dust coolant.
- Improvement to dust coolant structure.
- Rotary square structure.
- Equal speed.
- New type double column complex spindle head.
- Milling grinding complex spindle head.

## EXCELLENT · FEATURES · PROVIDE · VALUE

1988 Established "EQUIPTOP MACHINERY CO., LTD.". As a professional producer of high precision surface grinders.

1990 Developed ESG-618 & 818 ASD series, 3 axis fully automatic surface grinders. Used PC-CAD to upgrade mechanical design and development.

1992 Developed ESG-1228 & 1236 ASD series, 3 axis fully automatic surface grinders.

1993 Developed ESG-1632 & 1640 ASD series, 3 axis fully automatic surface grinders.

1995 Developed ESG-1020 & 1224 ASD series, 3 axis fully automatic surface grinders.  
Obtained CE-Mark certificate from AMTRI CE in England.

1997 Developed ESG-2448 to 2480, 3axis fully automatic, digital positioning ADX series, with a downfeed jog movement providing just 0.5  $\mu\text{m}$  super microfeed for finer production finish.

Column type surface grinder, using high anti-wear, heavy duty preloaded, H class linear guideway.

1998 Awarded ISO 9002 Certification by DNV company of Netherlands.

1999 Invested in "NANJING EQUIPTOP PRECISION MACHINERY CO., LTD." as branch in China.

2000 Developed ESG-3260 to 32120, 3axis fully automatic, smart digital positioning ADX series Received certified CE-MARK by DNV company.

2001 Awarded Certified ISO 9000 by Bell company.

Developed NC series, 3 axis fully automatic smart digital positioning grinders.

2002 Grand Opening of a new factory. The new facility is over 13,000m<sup>2</sup>.

Invested 1.6 hundred million dollars in this new headquarters.

Successfully developed new complex grinders, moving EQUIPTOP into the high technology area.

Renamed the company as "EQUIPTOP HITECH CORP."

2003 Awarded publication 2000 ISO 9001 certification. Developed "ASD II" series, 3 axis, fully automatic digital positioning grinders. Developed "ACUMEM" super microfeed servo control and auto-wheel dressing & compensation system grinders.

2004 Established the branch in Wu Hsi-Shuai Hung Precision Machinery LTD. to expand China market. Developed cantilever type ESG-6120~8300 ASD II series, 3 axis, fully automatic surface grinders.

2005 Obtained the prize of Taiwan Precision Product in manufacturing NC surface profile grinder.

2006 Developed ETM510APC tapping machine with auto pallet changer system & Double column grinding machine, table size 1500x3000~1500x5000 are available.

2008 Double column grinding machine, table size 1500x3000~1500x5000 are available.

2010 Upgrade ASD II series to TD type. PLC control & touch color screen.

2012 Double column type grinding machine, table size 1200x3000~1200x5000 are available.  
Developed ESG-2448 to 24120, 3axis fully automatic TD type with touch color screen.

2013 Execute rotary & square constitute, hydrostatic spindle and guide rail program.  
Presented EMV-600APC auto pallet change, and 800 x2000~5000mm, 1000x2000~5000 mm double column grinders.

2016 Developed and officially listed ECG-CNC Cylindrical Grinder series.

Innovation patented invention:

1. Innovation surface grinding machine controller: Patent No.:1546161
2. Innovation equal feeding speed control: Patent No.:M454893

3. Innovation rotary & square constitute design: Patent No.:1508818 & M454892

4. Innovation multi-sound alarm light structure: Patent No.: M486838

2016 Create 1224-TD Plus Man-machine PLC controller.

Publish ECG-27 / ECG-36 CNC Cylindrical grinding machine with man-machine controller.

Develop ERG-600 ERG-800 ERG-1000 CNC/PLC controller application.

2017 Presented at TIMTOS, March 2017, 1224-TD Plus, EG-36 CNC and ERG-600CNC, with man-machine controller. The operation and application showed in an Industrial 4.0 demonstration line.

Wining with honor: D&B TOP 1000 SMEs Elite Award

The 14th National brand: Remarkable enterprise Yushan Award.

Taichung city the 16th excellent SMEs Golden hand award.

Republic of China prominent enterprise management association, the 18th golden peak award:

Top 10 excellent business pioneer model.

Republic of China prominent enterprise management association, the 18th golden peak award:

Top 10 remarkable innovative research and development

2018 Golden torch prize: TD, ADC get Research and Innovation Award.

Golden torch prize: TD, ADC have the honor to win best satisfaction from customer.



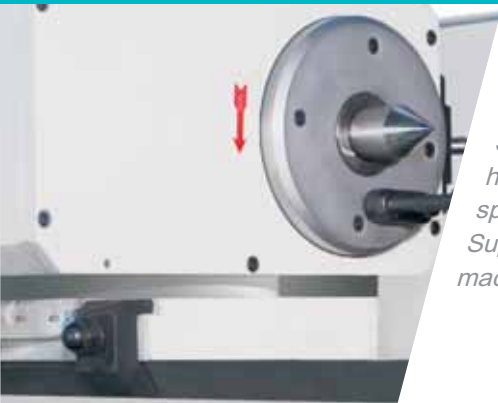

**Fixed center /  
Rotary center head stock**

Stable head stock equipped with high precision bearing, upgrade spindle rigidity and precision. Superior water-proof ability and machine durability.



**Manual / Hydraulic tailstock**

Oil filled type lubrication system for tailstock, to consolidate anti-water and dustproof protection, and ensure the high precision of the tailstock.



**High precision grinding head**

Spindle made of high class alloy steel (SNM220). By multi heat treatment, grinding, and polish machining for its durability. Spindle is supported by unique fluid dynamic bearing, to reach high rigidity and vibration resistant. (Touch probe is optional)



**ECG-2740 CNC  
CYLINDRICAL GRINDING MACHINE**

**ECG-2760 CNC**  
**CYLINDRICAL GRINDING MACHINE**  
*Full Guarded Splash Guard (option)*

**ECG-CNC · Best Choice**

*EQUIPTOP CNC cylindrical grinder – ECG-series is your best choice for high precision grinding work. The X axis and Z axis are driven by NC servo motor with precision ball screw. The CNC controller equipped with high performance control system for variable grinding jobs to create a user friendly operation environment to the operator.*



# ECG-2780 CNC

## CYLINDRICAL GRINDING MACHINE

Full Guarded Splash Guard (option)



Internal Grinding Attachment  
(Optional)



Swivel Over Table:  $\Phi$  270mm  
 Distance Between Centers: 800 mm  
 Max. Grinding Dia.:  $\Phi$ 250mm

### User Friendly Operation

- High performances CNC control system with GUI. The operator could input the grinding & dressing value follow the graphical description step by step for a complicated workpiece. The work process could turn to steps into the controller. Do not need to edit complex program as G CODE, M CODE as usual, provided the most convenient operation environment.

- GUI operation system equipped with variable work modes such as OD, ID, END-FACE and PROFILE for grinding & dressing applied for different work jobs. It could input the grinding & dressing value by numeralization way.
- Not only GUI mode but also CNC mode for operation could be chosen by operator.
- Install several shortcuts for practical function and emergency stop button on operation panel. Increase operational safety and convenience.
- Variable automatically measuring device could be chosen. Increase work quality and efficiency

Full Guarded Splash Guard (option)

## 27 / 35 Series CNC

Advanced CNC controller with filling type interface, contains editable standard grinding cycle program, and adjustable dressing shape for special grinding request.



## ECG-3540 CNC HIGH PRECISION CYLINDRICAL GRINDER

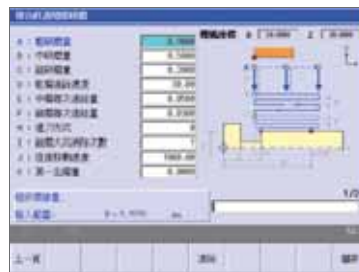

Grinding cycle diagram



Grinding wheel profile



Graphic selection for grinding and compound grinding

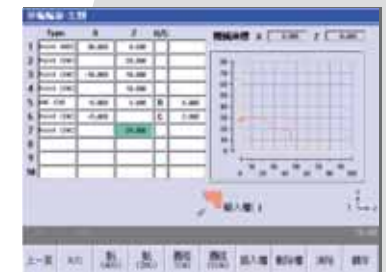

Grinding wheel profile overview

A detailed view of the ECG-3580 CNC cylindrical grinding machine. The machine is white with a black base and features a large grinding wheel on the left. A control panel with a screen and buttons is on the right. The machine is mounted on a black base. The text "EQUIPTOP. ECG-3580 CNC" is visible on the side of the machine.

***ECG-3580 CNC***  
***CYLINDRICAL GRINDING MACHINE***

***EQUIPTOP. ECG-3580 CNC***

Swivel Over Table:  $\Phi$  350mm  
Distance Between Centers: 800mm  
Max. Grinding Dia.:  $\Phi$  330mm  
Internal Grinding Attachment (option)



## INTERNAL GRINDING SPINDLE

The ration of grinding hole diameter to length is 1:3  
The max. grinding length is 150mm

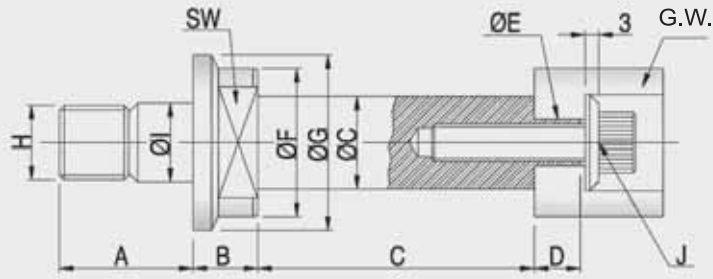

Grinding Dia.	Grease type	A	B	C	D	E	F	G	H	I	J	SW
Ø65~Ø150	8,000rpm	42	16	Ø40xØ100 Ø40xØ85 Ø40xØ55	12	Ø12	Ø50	Ø58	M26 x 2P	Ø28	M8 x 1.25P	41
Ø40~Ø80	10,000rpm	29	14	Ø30xØ90 Ø25xØ70 Ø20xØ60	10	Ø10	Ø32	Ø38	M16 x 1.5P	Ø17	M8 x 1.25P	24
Ø35~Ø70	15,000rpm	29	14	Ø30xØ90 Ø25xØ70 Ø20xØ60	10	Ø10	Ø32	Ø38	M16 x 1.5P	Ø17	M8 x 1.25P	24
Ø24~Ø40	20,000rpm	28	11	Ø24xØ80 Ø20xØ60 Ø16xØ40	8	Ø8	Ø26	Ø32	M14 x 1.5P	Ø15	M6 x 1.0P	19
Ø15~Ø25	30,000rpm	21	9	Ø16xØ40 Ø13xØ30 Ø10xØ25	6	Ø6	Ø21	Ø26	M10 x 1.5P	Ø10.5	M4 x 0.7P	17
Ø12~Ø16	40,000rpm	20	8	Ø12xØ35 Ø10xØ30 Ø8xØ25	x	x	Ø18	Ø23	M8 x 1.25P	Ø8.5	M4 x 0.7P	14
Ø9~Ø13	50,000rpm	18	7	Ø8xØ30 Ø7xØ25 Ø6xØ20	x	x	Ø15	Ø20	M7 x 1P	Ø7.5	M4 x 0.7P	11

**ECG-CNC · Best Choice**



Auto sizing (Optional)



Touch Probe (Optional)

## ECG External and Specification

Standard accessories	Optional accessories
Wheel & flange x 1 set	Digital readout for Z axis
Wheel extracting screw & net x 1 set	Diameter measurement
Diamond dresser x 1 set	Auto grinding wheel balancer
Tool box x 1 set	Hydraulic tailstock
Work-piece drive ring x 1 set	Manual 3-jaw chuck
Balancing stand and arbor x1 set	Hydraulic 3-jaw chuck
MT4 center x 2 PC	Oil mist collector
Heat exchanger in electric box	Magnetic separator
Coolant tank & pump	Paper filter
Grinding wheel inverter	Air conditioner in electric box
Gap eliminate anti-crash mechanism(current)	2-point center rack
Work lamp	3-point center rack
Digital readout for X axis	Work-piece support rack
	Grinding wheel suspending rack
	Grinding wheel hanger
	Gap eliminate anti-crash mechanism
	Internal grinding attachment

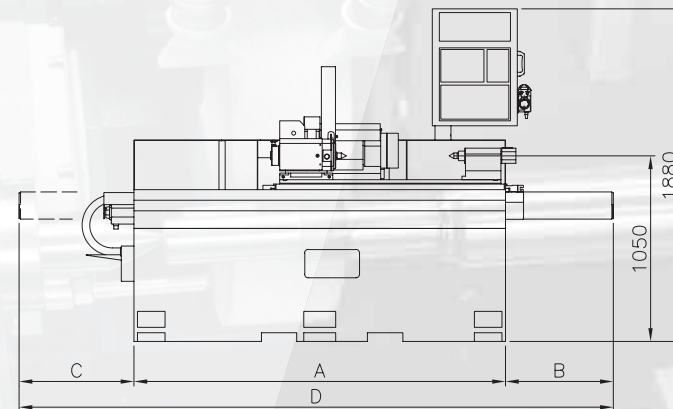
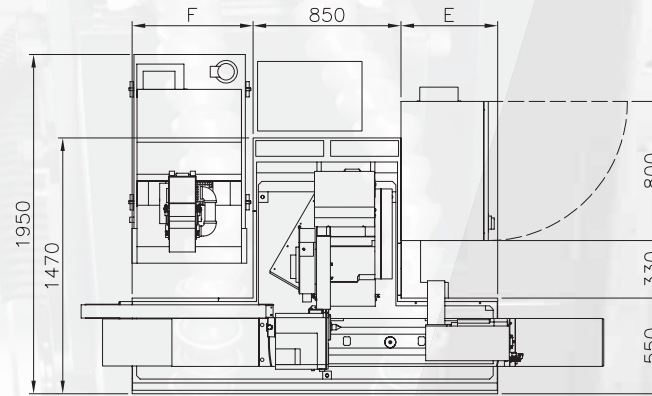

	400 Series	600 Series	800 Series	1000 Series
A	1700	2100	2500	2900
B	590	610	630	650
C	630	650	670	690
D	2920	3360	3800	4240
E	355	555	755	955
F	495	695	895	1095

### Wheel dressing cycle

#### Remark

1. Maximum setting is 5 sets for diamond dressing.
2. Five profile selections for wheel dressing. Both sides dressing is available.
3. Support custom profile function with drawing display. Max. 40-point settings.



SPECIFICATION Item		Unit	ECG-2740 CNC	ECG-2760 CNC	ECG-2780 CNC	ECG-3540 CNC	ECG-3560 CNC	ECG-3580 CNC	ECG-35100 CNC
Work Capability	Max. Grinding Dia.	mm	270			350			
	Distance between centers	mm	400	600	800	400	600	800	1000
	Center height	mm	136			176			
	Max. workpiece Weight	kgs	120			150			
Grinding Wheel	Grinding wheel size	mm	ψ405x32~50xψ152.4(opt.ψ455x50~80xψ152.4)						
	Grinding wheel speed	rpm	1650 (1890)						
	Rapid travel speed	m/sec	35(45)m/sec						
Wheel head	Feed angle	deg	90						
	Rapid travel speed	mm	6m / min						
	Min. Setting unit	mm	0.001						
	Max. Travel	mm	250						
Work head	Spindle speed	rpm	10~600						
	Center taper	MT	MT4						
	Spindle through hole Dia.	mm	25						
Tailstock	Travel sleeve	mm	30						
	Center taper	MT	MT4						
Work-table	Swivel angle	deg	-8 ~ +11	-6 ~ +9	-4 ~ +7	-8 ~ +11	-6 ~ +9	-4 ~ +7	-4 ~ +7
	Rapid traverse speed	mm	6m / min						
	Min. Setting unit	mm	0.001						
Motor	Grinding wheel spindle motor	hp	5 (option 7.5)						
	Work head motor	kw	1.0 (option1.5)						
	Wheel Spindle / Lubrication	hp	spindle cooling : 1/4 / coolant cooling : 1/4						
	Feeding (X axis)	kw	1.0 (1.2)						
	Feeding (Z axis)	kw	1.5 (1.8)						
N.W. (Approx.)	kgs	2600	3000	3400	2700	3100	3500	3900	
GW. (Approx.)	kgs	2800	3200	3600	2900	3300	3700	4100	
Packing size (LxWxH)	mm	2400 x 1970 x 2000	2800 x 1900 x 2000	3200 x 1900 x 2000	2400 x 1970 x 2000	2800 x 1900 x 2000	3200 x 1900 x 2000	3600 x 1900 x 2000	

Remark: 1) All pictures and drawings are only for reference 2) We reserve the right to modify any machine specification without prior notice.

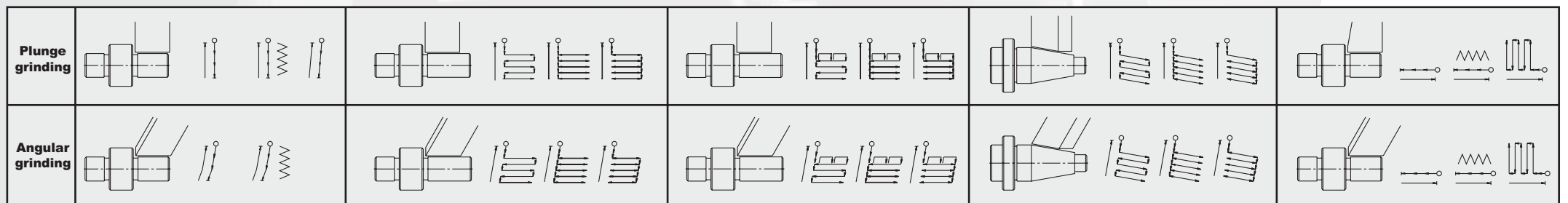

**Remark**

1. Separate setting for grinding cycle. Grinding cycle could be divided into rough grinding, medium grinding, and fine grinding, and spark-out grinding.

2. With diameter measurement device (option), grinding volume could be set for plunge or angular grinding.

# EQUIPTOP®



FAIR FRIEND GROUP



*"EQUIPTOP" means "TOP EQUIPMENT" A Wise Choice-Equiptop.*



**EQUIPTOP HITECH CORP.**

NO. 88, SAN FENG E. RD., HOULI DISTRICT,  
TAICHUNG CITY, TAIWAN 42156

■ TEL:+886-4-25576060

■ e-mail:equiptop@hibox.hinet.net

■ FAX:+886-4-25569677.25575866

■ <http://www.equiptop.com.tw>

*[www.equiptop.com.tw](http://www.equiptop.com.tw)*