

金垣興機械工業股份有限公司
CHIN YUAN HSING MACHINE INDUSTRIAL CO.,LTD

工廠地址：彰化縣芬園鄉茄荖村芳草路一段342巷170號
電話：886-049-2510279
傳真：886-049-2512897
網址：www.cyhmi.com http://cyh.hdv.tw/
電子信箱：cyhs1972@ms77.hinet.net

澤一數控（蘇州）有限公司
ZEYI CNC (SUZHOU) CO., LTD.

地址：江蘇省昆山市玉山鎮城南路196號
電話：0512-55272171

金垣興機械工業股份有限公司
CHIN YUAN HSING MACHINE INDUSTRIAL CO.,LTD

| 立式加工中心系列 | 龍門加工中心系列 | 臥式加工中心系列 |



公司簡介 Company Profile

金垣兴机械工业股份有限公司成立于 1972 年，以永续经营的企业理念与客户化的产品诉求，结合超过三十年工具机研发生产经验，努力不懈之下，秉持服务大众、回馈社会的意识，开创多方位企业，以专业的团队、贴心的服务为您付出。

遵循卓越创新的理念，传承的方式，极力培训人才、开拓市场，为公司载入品质第一与客户满意的境界。

Chin Yuan Hsing Machine Industrial Co., Ltd. was founded in 1972, with the concept of sustainable management and customer product demands, combined with more than 30 years of tool machine research and development and production experience, unremitting efforts, uphold the public, the consciousness of giving back to society, create a multi-faceted enterprise, with a professional team, intimate service for you to pay. Follow the concept of excellence and innovation, the way of inheritance, to train talents, expand the market, for the company into the quality first and customer satisfaction.

- ▶ **品质政策、卓越创新、技术精准、持续改善、客户满意。**
Quality policy, excellent innovation, precise technology, continuous improvement, and customer satisfaction.
- ▶ **品质目标，产品保固期内接近零故障。**
Quality target, product warranty period close to zero failure.
- ▶ **积极收集市场资讯，满足客户需求。**
Actively collect market information to meet customer needs.
- ▶ **定期校检设备，提升制造效率。**
Regularly inspect equipment to improve manufacturing efficiency.
- ▶ **落实教育训练，提高员工素质与品保制度。**
Implement education and training, improve employee quality and quality assurance system.



公司結構 Corporate structure

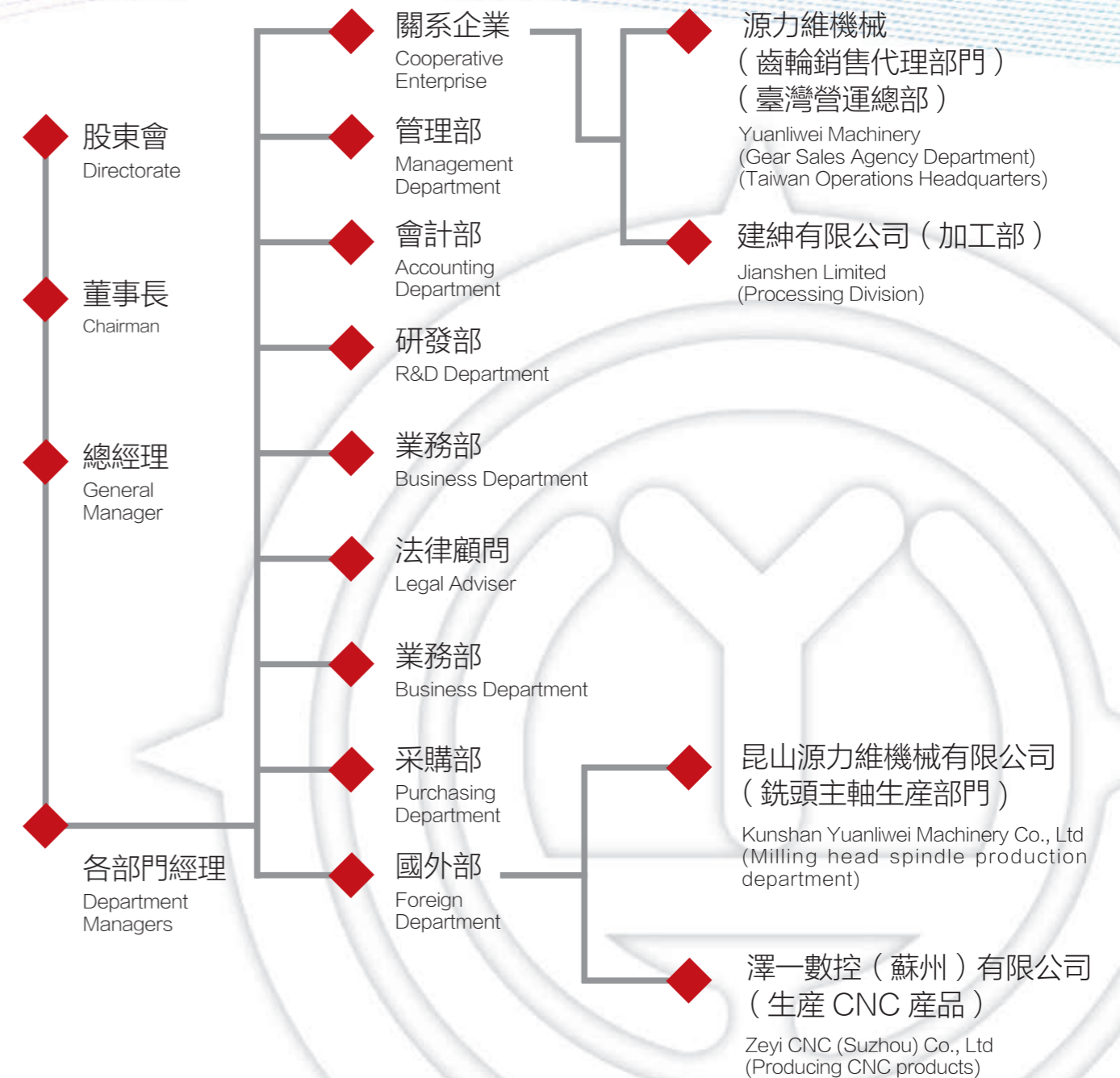



目錄 Catalogue

- 1** **CV8/CV11/CV12/CV13/CV15**
 高速立式加工中心系列
 Vertical High-speed Machining Center Series
- 5** **HMC-500/630**
 卧式加工中心系列
 Horizontal Machining Center Series
- 2** **CVMC-855/1160/1270/1370**
CVMC-1580/1690/1890
 立式綫軌加工中心系列
 Vertical Line Rail Machining Center Series
- 6** **T5/T6/T7**
 高速鑽孔攻牙機系列
 High Speed Drilling and Tapping Machine Series
- 3** **C850/1060/1270/1370**
C1580/1690/1890
 立式硬軌加工中心系列
 Vertical Hard Rail Machining Center Series
- 7** **CZ-150/200/250**
 數控車床系列
 CNC Lathe Series
- 4** **CFM-1614/2016/3015/3020**
CFM-4020/4025
CFM-6028/8028
 龍門加工中心系列
 CNC Gantry Machining Center Series
- 8** **CZ-200M/250M**
CZ-250MY
 車銑複合機床
 CNC Milling / Lathe Complex Machine

營業項目 Business item

臺灣廠 TAIWAN	金垣興機械 Chin Yuan Hsing Machinery	以生產龍門銑床、臥式銑床、數控加工中心機為主，如 CNC 龍門綜合加工機、CNC 大型龍門銑床、龍門平面磨床等。 To the production of gantry milling machine, horizontal milling machine, CNC machining center machine, such as CNC gantry comprehensive processing machine, CNC large gantry milling machine, gantry surface grinder.
昆山廠 KUNSHAN	源力維機械 Yuanliwei Machinery	銑床售後服務等業務工作，主軸搪銑削頭、精密齒輪銷售。 After-sale service of milling machine, spindle honing head, precision gear sales.
昆山廠 KUNSHAN	澤一數控 Zeyi CNC	立式加工中心，龍門加工中心，臥式加工中心等。 Vertical machining center, Longmen machining center, horizontal machining center, etc.





CV8/CV11/CV12/CV13/CV15

高速立式加工中心系列

Vertical High-speed Machining Center Series



機床特點 Machine tool characteristics

- 床身結構堅固、能承受高速運動產生的慣量。
- X/Y/Z三軸採用高速靜音螺絲、靜音線軌使熱變位少精度高。
- 48米調整位移，可節省非加工時間50%。
- 加高立柱設計，預留安裝第四、第五軸空間。
- 三軸護罩保護螺絲線軌提高機床使用壽命。
- The structure of the bed is strong and can withstand the inertia generated by high-speed movement.
- X/Y/Z three axis using high-speed silent screw, silent line rail to make less thermal displacement and high precision.
- 48m adjustment displacement, can save 50% non-processing time.
- Heightening column design, reserved for the installation of the fourth and fifth axis space.
- Three-axis shield protects screw rail and improves machine life.

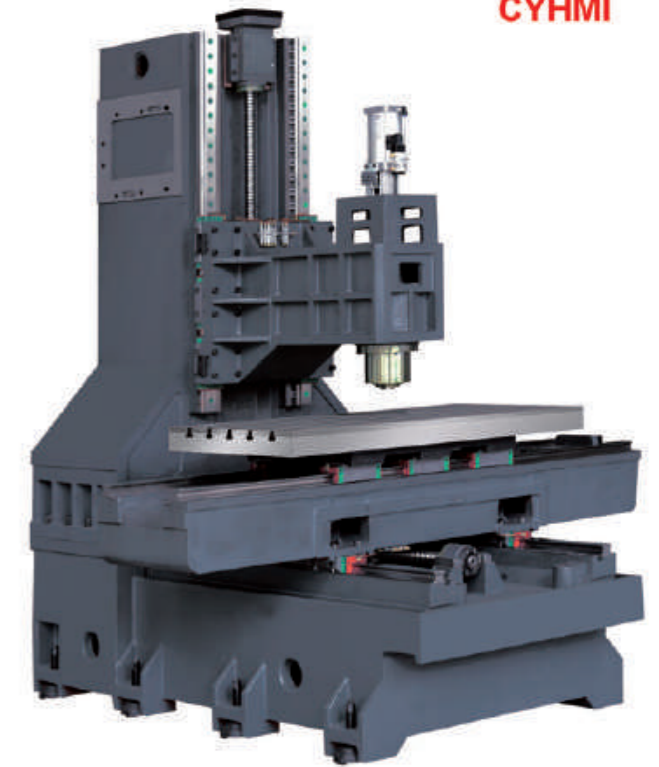

主要技術規格參數 Main technical specifications and parameters

項目 Item	單位 Unit	CV8	CV11	CV12	CV13	CV15
工作臺 Worktable						
工作臺尺寸 (長度 × 寬度) Worktable size (L × W)	mm	1000 × 500	1300 × 600	1360 × 700	1360 × 700	1700 × 800
工作臺最大載重 Maximum load of worktable	kg	350	800	1000	1000	1500
T型槽 (槽數 × 槽寬 × 間距) T-slot size	mm	5 × 18 × 90	5 × 18 × 100	5 × 18 × 122	5 × 18 × 122	5 × 22 × 135
加工範圍 Processing Range						
X軸行程 Longitudinal travel (X)	mm	800	1100	1200	1300	1500
Y軸行程 Cross travel (Y)	mm	500	600	700	700	800
Z軸行程 Vertical travel (Z)	mm	580	600	670	670	700
主軸端面至工作臺面距離 Distance from spindle nose to table	mm	80-660	120-720	170-840	170-840	130-830
主軸中心到立柱導軌面距離 Distance from Spindle Center to column surface	mm	520	650	785	785	810
主軸 Spindle						
主軸規格 Spindle specification		BT40	BT40	BT40/BT50	BT40/BT50	BT50
主軸轉速 (標準配置) Spindle speed (standard)	r.p.m	10000/12000	10000/12000	8000/12000	8000/12000	8000/12000
主軸傳動方式 Spindle drive mode		皮帶/直聯	皮帶/直聯	皮帶/直聯	皮帶/直聯	皮帶/直聯
主軸電機功率 Spindle motor power	kw	7.5/11	11/15	15/18.5(11/15)	15/18.5(11/15)	15/18.5(11/15)
電機扭力 (X/Y/Z) Motor torque	NM	11/11/20	20/20/20	27/27/27	27/27/27	27/27/27
進給系統 Feed system						
CNC系統 CNC system		FANUC-0i MF / MITSUBISHI M80 / SENMENS (可選配)				
X/Y/Z軸快移速度 X/Y/Z axis rapid trave speed	mm	48/48/48	30/30/30	24/24/20	24/24/20	20/20/20
刀庫 Tool storage						
刀庫容量 Tool storage capacity	把	24	24	24	24	24
精度 Accuracy						
定位精度 Positional accuracy	mm	±0.003/300	±0.003/300	±0.005/300	±0.005/300	±0.005/300
重復精度 Repeated positioning accuracy	mm	±0.002	±0.002	±0.003	±0.003	±0.005
空氣壓力 Air pressure						
空氣壓力 Air pressure	kg/cm ²	6	6	6	6	6
機器規格 Machine specifications						
機器重量 Machine weight	kg	5000	7000	9500	10000	12500
外形尺寸(長 × 寬 × 高) Shape size (L × W × H)	mm	2500 × 2500 × 2650	3160 × 2600 × 2850	3600 × 3000 × 3400	3600 × 3000 × 3400	4300 × 3500 × 3500

技術參數如有變化恕不另行通知。Technical parameters are subject to change without prior notice.



CVMC-855/1160/1270/1370 CVMC-1580/1690/1890

立式綫軌加工中心系列

Vertical Line Rail Machining Center Series



機床特點 Machine tool characteristics

- 床身結構堅固、能承受高速運動產生的慣量。
- X/Y兩軸採用高剛性的精密綫性導軌，同時搭配高精度C3級滾珠絲杆。以高扭矩、底噪音、高穩定性的AC數控伺服馬達驅動，可為多種材質加工提供不同速度。Z軸硬軌設計，極大提高Z軸加工剛性，切削更有力。
- 快速調整位移，可節省非加工時間50%。
- 加高立柱設計，預留安裝第四、第五軸空間。
- 精密滾珠絲杆與高速運動及高負荷綫性軌道、聯軸器緊密配合，確保在加工過程中的穩定。
- The structure of the bed is strong and can withstand the inertia generated by high-speed movement.
- X/Y axis adopts high rigidity precision linear guide rail, at the same time with high precision C3 level ball screw. Driven by AC NC servo motor with high torque, bottom noise and high stability, it can provide different speeds for a variety of material processing. Z axis hard rail design, greatly improve Z axis machining rigidity, cutting more powerful.
- Quick adjustment of displacement, can save non-processing time 50%.
- Heightening column design, reserved for the installation of the fourth and fifth axis space.
- Precision ball screw and high-speed movement and high load linear track, coupling closely match, to ensure stability in the process of processing.

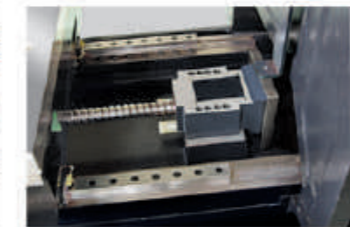
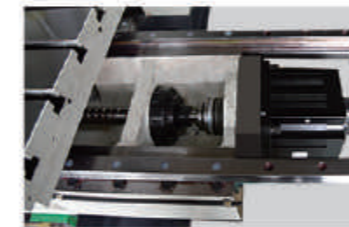

主要技術規格參數 Main technical specifications and parameters

項目 Item	單位 Unit	CVMC-855	CVMC-1160	CVMC-1270	CVMC-1370	CVMC-1580	CVMC-1690	CVMC-1890
工作臺 Worktable								
工作臺尺寸 (長度×寬度) Worktable size (L×W)	mm	1000×550	1300×600	1360×700	1360×700	1700×800	1800×900	2000×900
工作臺最大載重 Maximum load of worktable	kg	500	800	1000	1000	1500	1600	1600
T型槽 (槽數×槽寬×間距) T-slot size	mm	5×18×90	5×18×100	5×18×122	5×18×122	5×22×135	5×22×165	5×22×165
加工範圍 Processing Range								
X軸行程 Longitudinal travel (X)	mm	830	1100	1200	1300	1500	1600	1800
Y軸行程 Cross travel (Y)	mm	550	600	700	700	800	900	900
Z軸行程 Vertical travel (Z)	mm	550	600	600	600	700	845	845
主軸端面至工作臺面距離 Distance from spindle nose to table	mm	120-670	120-720	80-680	80-680	130-830	150-995	150-995
主軸中心到立柱導軌面距離 Distance from Spindle Center to column surface	mm	565	650	785	785	810	900	900
主軸 Spindle								
主軸規格 Spindle specification		BT40	BT40	BT40/BT50	BT40/BT50	BT50	BT50	BT50
主軸轉速 (標準配置) Spindle speed (standard)	r.p.m	8000/10000	8000/10000	8000/10000	8000/10000	6000/8000	6000	6000
主軸傳動方式 Spindle drive mode		皮帶傳動	皮帶傳動	皮帶傳動	皮帶傳動	皮帶傳動	皮帶傳動	皮帶傳動
主軸電機功率 Spindle motor power	kw	7.5/11	11/15	15/18.5(11/15)	15/18.5(11/15)	15/18.5	15/18.5	15/18.5
電機扭力 (X/Y/Z) Motor torque	NM	20/20/20	20/20/20	27/27/27	27/27/27	36/36/36	36/36/36	36/36/36
進給系統 Feed system								
CNC系統 CNC system		FANUC-0i MF / MITSUBISHI M80 / SENMENS (可選配)						
X/Y/Z軸快移速度 X/Y/Z axis rapid trave speed	mm	36/36/36	36/36/20	24/24/20	24/24/20	20/20/15	20/20/15	18/18/15
刀庫 Tool storage								
刀庫容量 Tool storage capacity	把	24	24	24	24	24	24	24
精度 Accuracy								
定位精度 Positional accuracy	mm	±0.003/300	±0.003/300	±0.005/300	±0.005/300	±0.005/300	±0.005/300	±0.005/300
重複精度 Repeated positioning accuracy	mm	±0.002	±0.002	±0.003	±0.003	±0.005	±0.005	±0.005
空氣壓力 Air pressure								
空氣壓力 Air pressure	kg/cm ²	6	6	6	6	6	6	6
機器規格 Machine specifications								
機器重量 Machine weight	kg	5800	7500	10000	10500	13000	13500	14500
外形尺寸(長×寬×高) Shape size (L×W×H)	mm	2500×2400×2650	3160×2600×2850	3600×3000×3400	3600×3000×3400	4300×3500×3500	4400×3500×3800	4500×3500×3800

技術參數如有變化恕不另行通知。Technical parameters are subject to change without prior notice.



C850/1060/1270/1370 C1580/1690/1890

立式硬軌加工中心系列

Vertical Hard Rail Machining Center Series



機床特點 Machine tool characteristics

- 寬廣的底座滑動軌道，大機型採用四軌式設計，所有滑軌均經過高周波熱處理，且精密研磨，配合耐磨耗之氟化樹脂、低阻力、低摩擦係數，相互平穩滑動，確保機臺精度。
- 每軸兩端支持座共採用五個滾珠螺桿專用軸承加以預拉，以確保熱膨脹時之精密度。
- 採用高密度連軸器直接傳動減少傳動間隙。
- 三軸方向均採用全密閉式山形伸縮護蓋，封閉性及排屑性能均屬上乘。
- Broad base sliding track, large models using four-track design, all the rails are through high frequency heat treatment, and precision grinding, with wear resistance fluorinated resin, low resistance, low friction coefficient, smooth sliding each other, to ensure the accuracy of the machine.
- A total of five ball screw bearings are used at both ends of each shaft to prepull, to ensure the precision of thermal expansion.
- Adopt high density coupling direct transmission to reduce transmission clearance.
- Three axes are fully closed mountain telescopic cover, sealing and chip removal performance are superior.

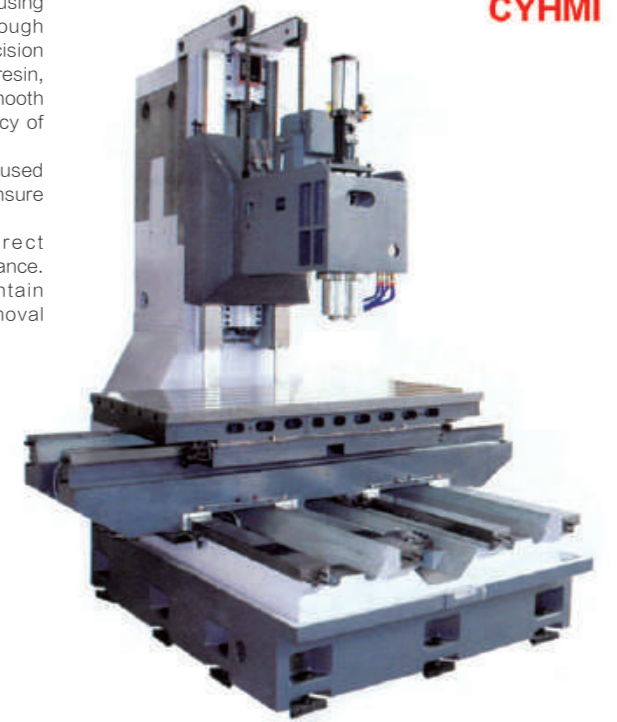
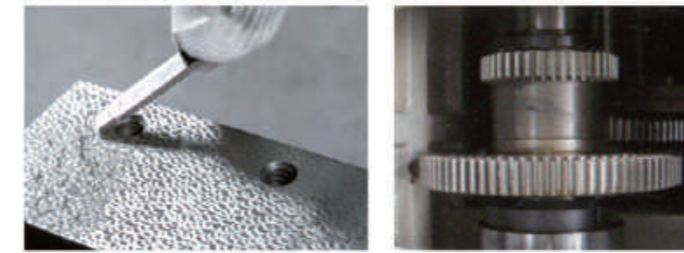

主要技術規格參數 Main technical specifications and parameters

項目 Item	單位 Unit	C850	C1060	C1270	C1370	C1580	C1690	C1890
工作臺 Worktable								
工作臺尺寸 (長度 × 寬度) Worktable size (L × W)	mm	1100 × 500	1300 × 600	1360 × 700	1360 × 700	1700 × 800	1800 × 900	2000 × 900
工作臺最大載重 Maximum load of worktable	kg	500	800	1000	1000	1500	1600	1600
T型槽 (槽數 × 槽寬 × 間距) T-slot size	mm	5 × 18 × 90	5 × 18 × 120	5 × 18 × 152.5	5 × 18 × 152.5	5 × 22 × 135	5 × 22 × 165	5 × 22 × 165
加工範圍 Processing Range								
X軸行程 Longitudinal travel (X)	mm	800	1000	1200	1300	1500	1600	1800
Y軸行程 Cross travel (Y)	mm	500	600	700	700	800	900	900
Z軸行程 Vertical travel (Z)	mm	550	600	680	680	700	845	845
主軸端面至工作臺面距離 Distance from spindle nose to table	mm	105-655	120-720	87-767	87-767	197-897	150-995	150-995
主軸中心到立柱導軌面距離 Distance from Spindle Center to column surface	mm	550	600	785	785	810	900	900
主軸 Spindle								
主軸規格 Spindle specification		BT40	BT40	BT50	BT50	BT50	BT50	BT50
主軸轉速 (標準配置) Spindle speed (standard)	r.p.m	8000	8000	8000	8000	6000	6000	6000
主軸傳動方式 Spindle drive mode		皮帶傳動	皮帶傳動	皮帶傳動	皮帶傳動	皮帶傳動	皮帶傳動	皮帶傳動
主軸電機功率 Spindle motor power	kw	7.5/11	11/15	11/15	11/15	15/18.5	15/18.5	15/18.5
電機扭力 (X/Y/Z) Motor torque	NM	11/11/11	20/20/20	27/27/27	27/27/27	36/36/36	36/36/36	36/36/36
進給系統 Feed system								
CNC系統 CNC system		FANUC-0i MF / MITSUBISHI M80 / SENMENS (可選配)						
X/Y/Z軸快移速度 X/Y/Z axis rapid trave speed	mm	16/16/16	16/16/16	16/16/16	16/16/16	15/15/15	15/15/15	15/15/15
刀庫 Tool storage								
刀庫容量 Tool storage capacity	把	24	24	24	24	24	24	24
精度 Accuracy								
定位精度 Positional accuracy	mm	±0.003/300	±0.003/300	±0.005/300	±0.005/300	±0.005/300	±0.005/300	±0.005/300
重複精度 Repeated positioning accuracy	mm	±0.002	±0.002	±0.003	±0.003	±0.005	±0.005	±0.005
空氣壓力 Air pressure								
空氣壓力 Air pressure	kg/cm ²	6	6	6	6	6	6	6
機器規格 Machine specifications								
機器重量 Machine weight	kg	5300	7500	10000	10500	13000	13500	14500
外形尺寸 (長 × 寬 × 高) Shape size (L × W × H)	mm	2400 × 2100 × 2500	3500 × 2700 × 2650	3600 × 3000 × 2700	3600 × 3000 × 2700	4300 × 3500 × 3500	4400 × 3500 × 3800	4500 × 3500 × 3800

技術參數如有變化恕不另行通知。Technical parameters are subject to change without prior notice.



CFM-1614/2016/3015/3020 CFM-4020/4025 CFM-6028/8028

龍門加工中心系列 CNC Gantry Machining Center Series



機床特點 Machine tool characteristics

- 強大的切削能力與卓越的精確度和性能相結合，令銑削與鏜孔操作簡單易行。
 - 主軸頭可以選配油壓鎖緊方式的90°側銑頭。
 - 機床床身、立柱、橫梁、滑鞍、主軸箱採用樹脂砂造型的高強度鑄鐵以及合理的布筋結構，剛性好，穩定性強。
 - 主運動採用寬調速交流伺服主電機，選配ZF變速，使得主軸在低速時大扭矩輸出，適合重切削，高轉速時的恒功率適合精加工。
- Strong cutting ability combined with excellent accuracy and performance, making milling and boring operation simple and easy.
 - The 90° side milling neck with oil pressure locking is optional for the main shaft head.
 - Machine bed, column, beam, saddle, headstock using resin sand modeling of high strength cast iron and reasonable fabric structure, good rigidity, strong stability.
 - The main movement adopts wide speed control AC servo motor, optional ZF speed change, so that the main shaft at low speed of large torque output, suitable for heavy cutting, high speed of constant power suitable for finishing.

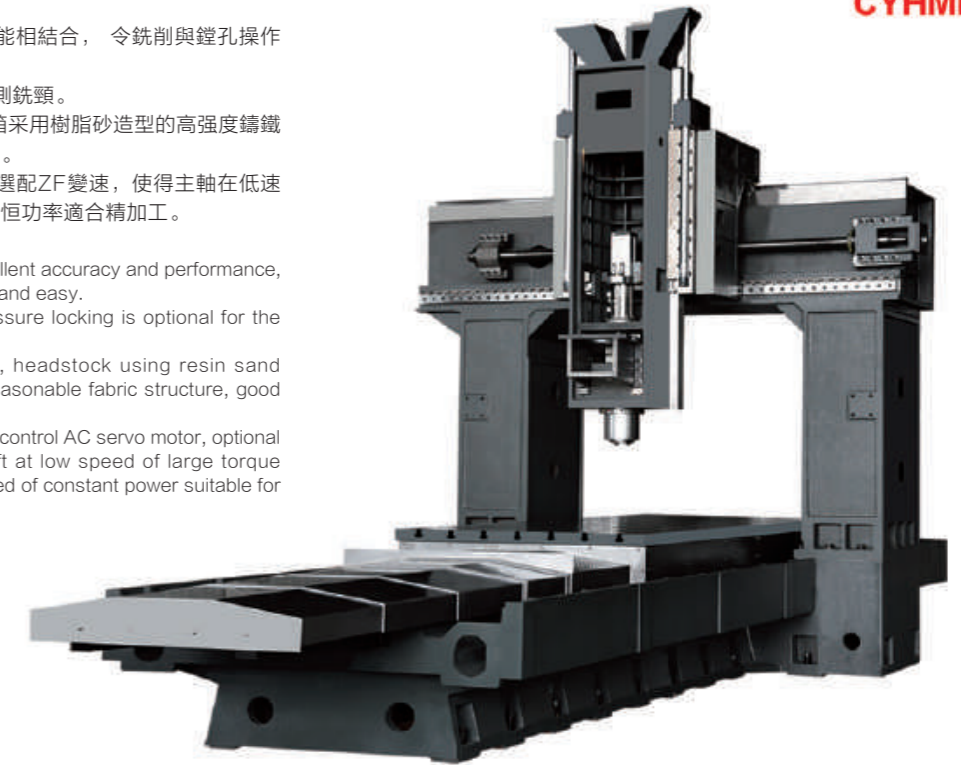

主要技術規格參數 Main technical specifications and parameters

項目 Item	單位 Unit	CFM-1614	CFM-2016	CFM-3015	CFM-3020	CFM-4020	CFM-4025	CFM-6028	CFM-8028
工作臺 Worktable									
工作臺尺寸(長度×寬度) Worktable size (L×W)	mm	1800×1400	2000×1600	3000×1500	3200×2000	4200×2000	4200×2000	6000×2500	8000×2500
工作臺最大載重 Maximum load of worktable	T	4	6	6	8	10	12	25	30
T型槽(槽數×槽寬×間距) T-slot size	mm	7×22×160	7×22×150	9×22×150	11×22×175	11×22×175	11×22×175	12×28×200	12×28×200
加工範圍 Processing Range									
X軸行程 Longitudinal travel (X)	mm	1600	2000	3000	3200	4200	4200	6200	8200
Y軸行程 Cross travel (Y)	mm	1400	1600	1700	2300	2300	2500	2800	2800
Z軸行程 Vertical travel (Z)	mm	750	800	860	1000	1000	1000	1000	1000
主軸端面至工作臺面距離 Distance from spindle nose to table	mm	200-950	150-950	340-1200	175-1175	175-1175	175-1175	310-1310	310-1310
龍門寬度 Gantry width	mm	1500	1600	1700	2300	2300	2500	2800	2800
主軸 Spindle									
主軸規格 Spindle specification		BT40/HSKA63	BT50	BT50	BT50	BT50	BT50	BT50	BT50
傳動方式A Spindle drive mode A	r.p.m	直聯12000				皮帶傳動: 最高6000rpm (減速1.5: 1選配)			
傳動方式B Spindle drive mode B		電主軸24000/30000				ZF減速箱+皮帶傳動: 最高6000rpm (兩檔減速1: 1; 4: 1)			
傳動方式C Spindle drive mode C		無				齒輪箱傳動: 最高6000rpm (兩檔減速1: 1; 4.4: 1)			
主軸電機功率 Spindle motor power	kw	選裝	15/18.5	15/18.5	15/18.5	15/18.5	15/18.5	22/26	22/26
進給系統 Feed system									
CNC系統 CNC system		FANUC-0i MF / MITSUBISHI M80 / SENMENS (可選配)				FANUC-0i MF / MITSUBISHI M80 / SENMENS (可選配)			
X/Y/Z軸快移速度 X/Y/Z axis rapid trave speed	mm	12/12/12	12/12/10	12/12/10	12/12/10	10/12/10	10/12/10	6/12/10	6/12/10
刀庫 Tool storage									
刀庫容量 Tool storage capacity	把	24	24	24	24	24	24	24	24
精度 Accuracy									
定位精度 Positional accuracy	mm	0.016	0.016	0.016	0.016	0.02	0.03/0.02/0.016	0.035/0.025/0.016	0.04/0.025/0.016
重複精度 Repeated positioning accuracy	mm	0.012	0.012	0.012	0.012	0.016	0.02/0.012/0.01	0.025/0.016/0.01	0.03/0.016/0.01
空氣壓力 Air pressure									
空氣壓力 Air pressure	kg/cm ²	6	6	6	6	6	6	6	6
機器規格 Machine specifications									
機器重量(約) Machine weight	T	19	17	21	28	32	36	66	76
外形尺寸(長×寬×高) Shape size (L×W×H)	mm	5100×3000×4200	8000×4000×4500	9400×4100×4500	8400×4500×4500	11400×4500×4500	13500×5400×5000	15500×5700×5200	19500×5700×5200

技術參數如有變化恕不另行通知。Technical parameters are subject to change without prior notice.

選購配件 Optional Accessories



動樑式機種選配
▼ Opt. Acc. of CNC Sliding Beam type

◀ 四方滑枕 SQUARE RAM



高精度主軸
 • 高負荷、高精度主軸培林，配合高 / 低檔齒輪箱之設計，使主軸具備高剛性、高扭矩、高精度之切削能力。
 • 主軸中心出水 (選配)。
HIGH PRECISION SPINDLE
 • The spindle runs in heavy duty, high precision bearings in combination with the gearbox transmission with high/low speed change, enabling the spindle to exhibit high rigidity, high torque and high precision cutting capacity.
 • Coolant through spindle (optional).

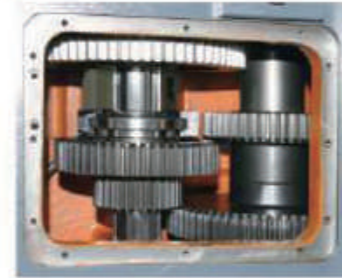

兩段變速齒輪箱
 • 高 / 低速兩段變速。
 • 低速時具有高扭力輸出，適合重切削。
 • 高速可達 6000rpm，可做精密銑削。
 • 噴油式潤滑。
GEARBOX WITH 2-STEP SPEED CHANGE
 • Two-step high / low speed change.
 • Low speed range provides high torque output for heavy cutting application.
 • Maximum speed can reach 6000rpm for fine finishing.
 • Oil splash lubrication.

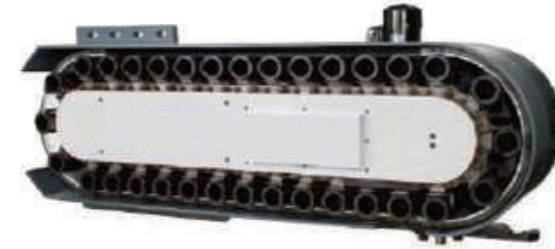

鍊條式刀庫 Side-mount Chain Type Magazine
 • 可選擇 32、40 或 60 支刀。
 • A Choice of 32, 40 or 60 Tools is Available.



圓盤式刀庫 Disk Type Magazine
 • 為 24 支刀。
 • Load Capacity is 24 Tools.



Schneeberger 線性光學尺
 針對工作台長度為 5,000mm 或以上，X 軸可配備一個 Schneberger 線性標尺。
Schneeberger Linear Scales
 For models with table length 5,000mm and over, X-axis is available to equip with a Schneberger linear scale.



海德漢 線性光學尺
 定位精度高的直線尺
 可用於 X-Y 和 Z 軸。
HEIDENHAIN Linear Scales
 Linear scales for high positioning accuracy are available for the X, Y and Z-axis.

主軸轉速/扭力曲線圖 SPINDLE SPEED / TORQUE DIAGRAM

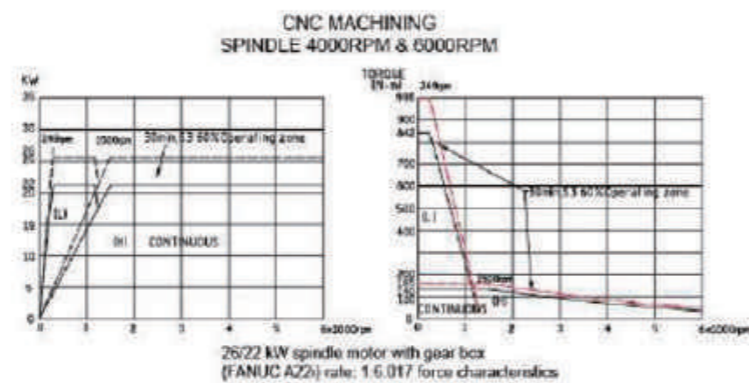
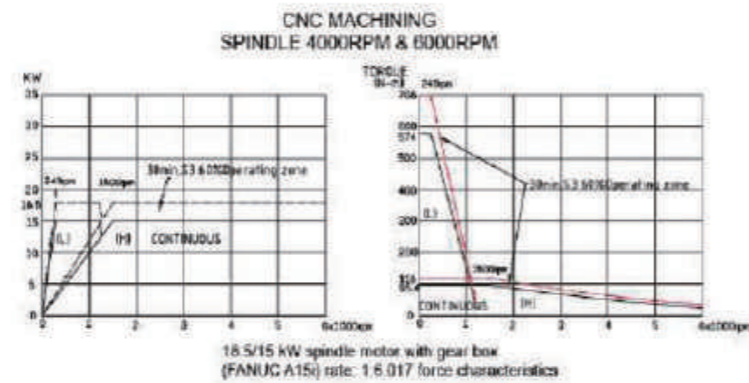

側銑頭 Horizontal Milling Head
 適用於 90° 銑削與側面基準面銑削。可大幅縮短工件加工時間，提升效率。
 Suitable for 90° milling and side milling for a reference plane; greatly shortening machining time while increasing efficiency.



16/20 支刀庫的選擇裝置，提供客戶自動換刀及多刀選擇。
 Option 16/20 pcs ATC tool changer.



全自動萬能頭
 Fully automatic change universal milling head



90° 直角銑頭
 Angular head



45° 萬能銑頭
 Universal head



90° 萬能銑頭
 Universal head



半自動直角銑頭
 Semi-automatic angular head + Position chaining 90° angle head



90° 直角銑頭
 Angular head



深孔直角銑頭
 90° Deep head



延伸銑頭
 Extend head



HMC-500/630

卧式加工中心系列
Horizontal Machining
Center Series

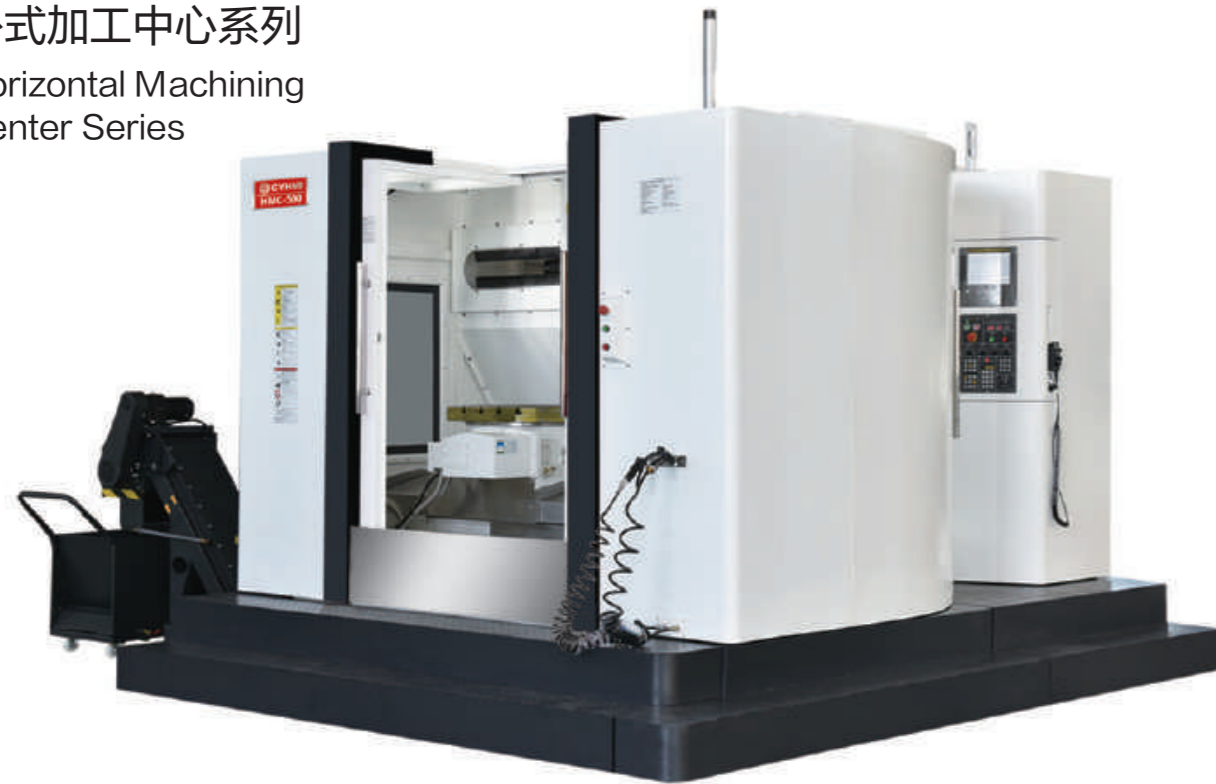

主要技術規格參數 Main technical specifications and parameters

項目 Item	單位 Unit	HMC500	HMC630
工作臺面積 Worktable area	mm	500×500	630×630
工作臺最大載重 Maximum load of worktable	kg	600	1200
T型槽 (槽數×槽寬×間距) T-slot size	mm	5×18×100	5×20×125
轉臺分割角度 Turntable division Angle	deg	1° /0.001°	1° /0.001°
X軸行程 Longitudinal travel (X)	mm	800	1050
Y軸行程 Cross travel (Y)	mm	650	800
Z軸行程 Vertical travel (Z)	mm	700	850
主軸端面至工作臺中心距離 Distance from spindle nose to table	mm	120-820	200-1100
主軸中心到工作臺面距離 Distance from spindle center to worktable	mm	0-650	118-968
主軸規格 Spindle specification		BT50	BT50
主軸轉速 (標準配置) Spindle speed (standard)	r.p.m	6000	6000
主軸傳動方式 Spindle drive mode		皮帶傳動	皮帶傳動
主軸電機功率 Spindle motor power	kw	15/18.5	15/18.5 (22/26)
電機扭力(X/Y/Z) Motor torque	NM	30/30/30	36/36/36
CNC系統 CNC system		FANUC-0i MF MITSUBISHI M80 SENMENS (可選配)	
X/Y/Z軸快移速度 X/Y/Z axis rapid trave speed	mm	48/48/48	30/30/30
刀庫容量 Tool storage capacity	把	24T/30T	30T/40T
定位精度 Positional accuracy	mm	0.008	0.008
重複精度 Repeated positioning accuracy	mm	0.005	0.005
空氣壓力 Air pressure	kg/cm ²	6	6
機器重量 Machine weight	kg	8000	17000
外形尺寸 (長×寬×高) Shape size (L×W×H)	mm	2900×3500×2850	4500×3500×3500

技術參數如有變化恕不另行通知。Technical parameters are subject to change without prior notice.

T5/T6/T7

高速鑽孔攻牙機系列
High Speed Drilling and Tapping
Machine Series



機床特點 Machine tool characteristics

- 高速主軸電機直接驅動主軸，實現高速且高精度的加工；
 - 搭載進口21T斜盤刀庫，換刀快速穩定；
 - 機床大傾斜排屑角度，機床迅速衝淨切屑，並且加快切削液的回流速度；
 - 強大的機電一體化應用技術，提高傳動鏈的響應速度，消除加工過程中的無動作，減少非切削時間，顯示提升生產效率。
- High speed spindle motor directly drives the spindle to realize high speed and high precision machining;
 - Equipped with imported 21T swash plate tool library, quick and stable tool change;
 - Large tilt chip removal Angle, the machine quickly flushes the chip, and speeds up the reflux speed of cutting fluid;
 - Powerful mechatronic application technology, improve the response speed of the transmission chain, eliminate no action in the process of processing, reduce the non-cutting time, show to improve production efficiency.

主要技術規格參數 Main technical specifications and parameters

項目 Item	單位 Unit	T5	T6	T7
工作臺尺寸 (長度×寬度) Worktable size (L×W)	mm	650×400	700×400	800×400
工作臺最大載重 Maximum load of worktable	kg	250	250	300
T型槽 (槽數×槽寬×間距) T-slot size	mm	3×14×125	3×14×125	3×14×125
X軸行程 Longitudinal travel (X)	mm	500	600	700
Y軸行程 Cross travel (Y)	mm	400	400	400
Z軸行程 Vertical travel (Z)	mm	320	320	320
主軸端面至工作臺面距離 Distance from spindle nose to table	mm	130-450	130-450	130-450
主軸中心到立柱導軌面距離 Distance from Spindle Center to column surface	mm	410	410	410
主軸規格 Spindle specification		BT30	BT30	BT30
主軸轉速 (標準配置) Spindle speed (standard)	r.p.m	20000	20000	20000
主軸傳動方式 Spindle drive mode		直聯傳動	直聯傳動	直聯傳動
主軸電機功率 Spindle motor power	kw	3.7/5.5	3.7/5.5	3.7/5.5
電機扭力(X/Y/Z) Motor torque	NM	8/8/12	8/8/12	8/8/12
CNC系統 CNC system		FANUC-0i MF / MITSUBISHI M80 / 華中818A (可選配)		
X/Y/Z軸快移速度 X/Y/Z axis rapid trave speed	mm	48/48/48	48/48/48	48/48/48
刀庫容量 Tool storage capacity	把	16T/21T	16T/21T	16T/21T
定位精度 Positional accuracy	mm	0.008	0.008	0.008
重複精度 Repeated positioning accuracy	mm	0.005	0.005	0.005
空氣壓力 Air pressure	kg/cm ²	6	6	6
機器重量 Machine weight	kg	3200	3500	3800
外形尺寸 (長×寬×高) Shape size (L×W×H)	mm	1900×2340×2450	1900×2340×2450	2040×2340×2450

技術參數如有變化恕不另行通知。Technical parameters are subject to change without prior notice.



CZ-150/200/250

數控車床系列
CNC Lathe Series



主要技術規格參數 Main technical specifications and parameters

項目 Item		單位 Unit	CZ-150	CZ-200	CZ-250
主軸 Spindle	主軸鼻端形式 Spindle nasal form		A2-5	A2-6	A2-8
	主軸通孔直徑 Diameter of main shaft through hole	mm	48	61	87
	三爪卡盤夾持能力 Three jaw chuck clamping ability	mm	6"/ Φ 150	8"/ Φ 210	10"/ Φ 250
	拉桿動作形式 Pull rod action form		液壓	液壓	液壓
驅動系統 Driving system	主軸電機功率 Spindle motor power	KW	5.5/7.5	11/15	15/18.5
	主軸最高轉速 Maximum spindle speed	rpm	4000	4500	3500
	X軸伺服電機功率 X-axis servo motor power	KW	1.8	1.8	1.8
加工範圍 Processing range	Z軸伺服電機功率 Z-axis servo motor power	KW	2.5	2.5	2.5
	最大床身旋徑 Maximum bed rotation diameter	mm	400	480	650
	最大加工工件長度 Maximum length of machined workpiece	mm	350	450	650
	最大加工工件直徑 Maximum workpiece diameter	mm	Φ 220	Φ 260	Φ 520/420
X/Z軸 X/Z axis	最大拉杆通孔直徑 Maximum rod through hole diameter	mm	Φ 45	Φ 52	Φ 75
	Z軸行程 Z-axis stroke	mm	220	480	660/650
	X軸行程 X-axis stroke	mm	150/360	220	280/260
精度 Accuracy	X/Z軸快速位移 Rapid X/Z displacement	m/min	20	20	18-30
	定位精度 Positioning accuracy	mm	\pm 0.005	\pm 0.005	\pm 0.005
	重復定位精度 Repeated positioning accuracy	mm	\pm 0.003	\pm 0.003	\pm 0.003
動力伺服刀塔 Power servo cutter tower	中心高 Center height		80	100	100
	刀塔轉動形式 Knife tower rotation form		排刀	伺服刀塔	伺服刀塔
	刀位數 Tool number		-	8/12	12
	方刀座規格 Square tool holder specification	mm	-	20/25	25
	鏜刀座規格 Boring tool holder specification	mm	-	32/40	40
尾座 Tail seat	Y行程 Y-stroke		-	-	-
	頂尖規格 Top specification	mm	-	-	Mt5
	尾座行程 Tail-seat travel	mm	-	-	625
水箱 Water tank	最大頂持工件長度 Maximum holding workpiece length	mm	-	-	580
	切削水箱容量 Cutting tank capacity	L	80	120	150
電力需求 Electricity demand	切削水水壓力 Cutting water pressure	bar	0.8	2.3	2.8
	電壓 Voltage	vac	380 \pm 10%	380 \pm 10%	380 \pm 10%
機床尺寸 Machine tool size	功率 Power	KVA	15	22	25
	相數 Phase number	phase	3	3	3
	頻率 Frequency	Hz	20/30	50/60	50/60
機床尺寸 Machine tool size	長 \times 寬 \times 高 (L \times W \times H)	mm	1900 \times 1450 \times 1650	2070 \times 1580 \times 1750	2900 \times 1800 \times 1960
	重量 Weight	kg	2000	3000	5000

技術參數如有變化恕不另行通知。Technical parameters are subject to change without prior notice.

CZ-200M/250M/250MY

車銑復合機床
CNC Milling / Lathe Complex Machine



主要技術規格參數 Main technical specifications and parameters

項目 Item		單位 Unit	CZ-200M	CZ-250M	CZ-250MY
主軸 Spindle	主軸鼻端形式 Spindle nasal form		A2-6	A2-8	A2-6
	主軸通孔直徑 Diameter of main shaft through hole	mm	61	87	61
	三爪卡盤夾持能力 Three jaw chuck clamping ability	mm	8"/ Φ 210	10"/ Φ 254	8"/ Φ 210
	拉桿動作形式 Pull rod action form		液壓	液壓	液壓
驅動系統 Driving system	主軸電機功率 Spindle motor power	KW	11/15A	15/18.5	11/15
	主軸最高轉速 Maximum spindle speed	rpm	4500	3500	4500
	X軸伺服電機功率 X-axis servo motor power	KW	1.8	1.8	1.8
加工範圍 Processing range	Z軸伺服電機功率 Z-axis servo motor power	KW	2.5	2.5	2.5
	最大床身旋徑 Maximum bed rotation diameter	mm	500	650	650
	最大加工工件長度 Maximum length of machined workpiece	mm	420	650	600
	最大加工工件直徑 Maximum workpiece diameter	mm	Φ 280	Φ 520/420	Φ 500/420
X/Z軸 X/Z axis	最大拉杆通孔直徑 Maximum rod through hole diameter	mm	Φ 52	Φ 75	Φ 61
	Z軸行程 Z-axis stroke	mm	460	660/650	660/650
	X軸行程 X-axis stroke	mm	220	280/260	280/260
精度 Accuracy	X/Z軸快速位移 Rapid X/Z displacement	m/min	10-30	10-30	10-30
	定位精度 Positioning accuracy	mm	\pm 0.005	\pm 0.005	\pm 0.005
	重復定位精度 Repeated positioning accuracy	mm	\pm 0.003	\pm 0.003	\pm 0.003
動力伺服刀塔 Power servo cutter tower	中心高 Center height		80	100	100
	刀塔轉動形式 Knife tower rotation form		動力伺服刀塔	動力伺服刀塔	Y 動力伺服刀塔
	刀位數 Tool number		12	12	12
	方刀座規格 Square tool holder specification	mm	20/25	25	25
	鏜刀座規格 Boring tool holder specification	mm	32	40	40
尾座 Tail seat	Y行程 Y-stroke		-	-	\pm 50
	頂尖規格 Top specification	mm	Mt5	Mt5	Mt5
	尾座行程 Tail-seat travel	mm	400	625	625
水箱 Water tank	最大頂持工件長度 Maximum holding workpiece length	mm	420	580	580
	切削水箱容量 Cutting tank capacity	L	120	150	150
電力需求 Electricity demand	切削水水壓力 Cutting water pressure	bar	2.3	2.8	2.3
	電壓 Voltage	vac	380 \pm 10%	380 \pm 10%	380 \pm 10%
機床尺寸 Machine tool size	功率 Power	KVA	22	25	25
	相數 Phase number	phase	3	3	3
	頻率 Frequency	Hz	50/60	50/60	50/60
機床尺寸 Machine tool size	長 \times 寬 \times 高 (L \times W \times H)	mm	2070 \times 1580 \times 1750	2900 \times 1800 \times 1960	2660 \times 1760 \times 2160
	重量 Weight	kg	3100	5000	5000

技術參數如有變化恕不另行通知。Technical parameters are subject to change without prior notice.