

混合式馬達啟動器

菲尼克斯原廠授權代理商 —— 「睿豐自動化」

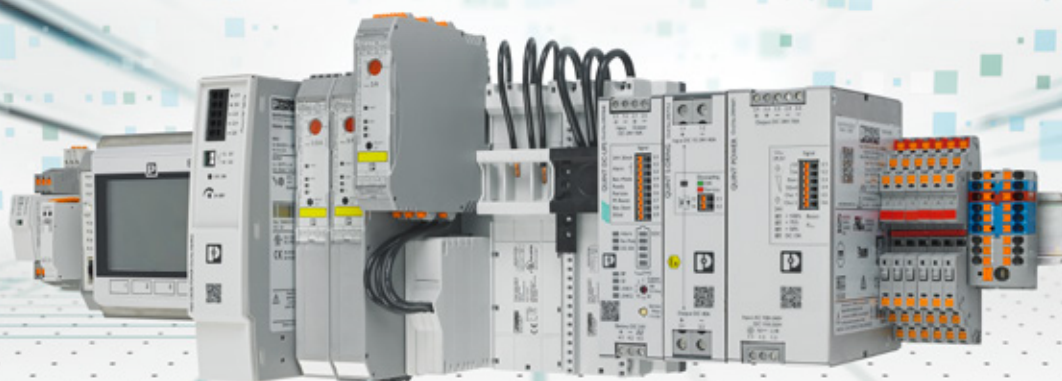

CONTACTRON 系列 CONTACTRON Pro 系列

- 正轉、反轉、積熱電驛、緊急停止功能
- 混合技術讓使用壽命延長 10 倍
- 額定電流 0.6A、2.4A、3A、9A
- 全系列產品 22.5 mm 寬
- Push-in 拔插式連接



印刷電路板用端子台、插拔式連接器

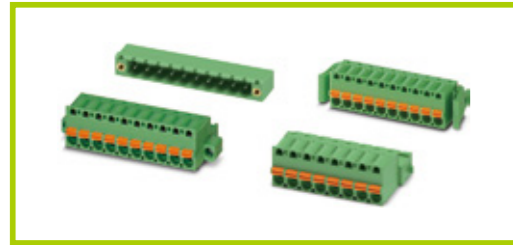

網路安全/遠端存取



電子裝置用外殼



無線裝置



控制器



機殼/電路板安裝用接頭



電源供應器



斷路器



標記印表機、零組件



UPS 系統



繼電器



工具



突波保護器

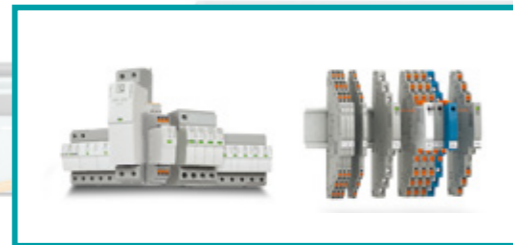

配件



控制用端子台

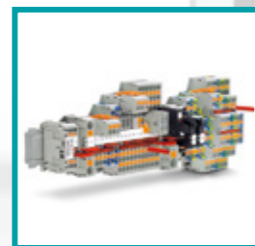

大電流用端子台



工控元件 REFO 找睿豐

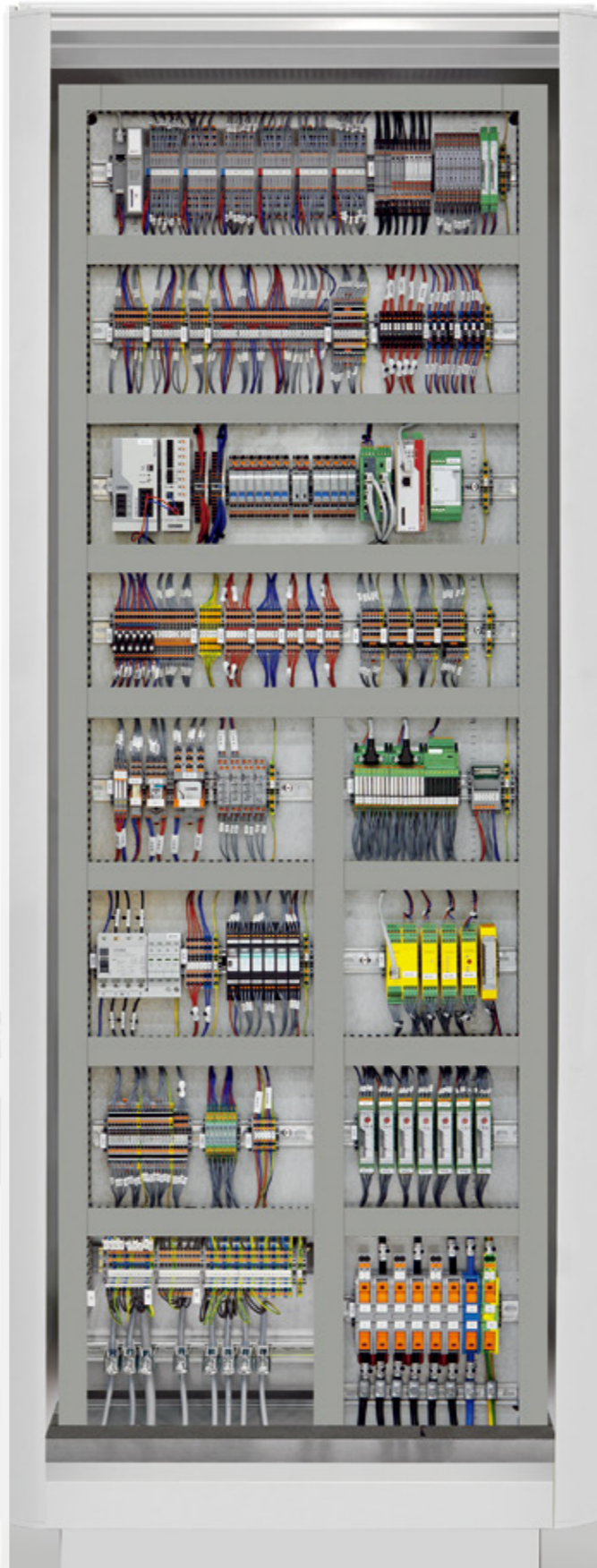

類比信號轉換器

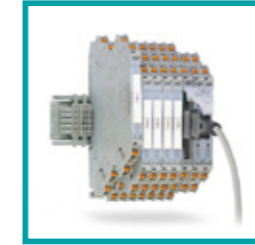

LED照明



HMI / 工業用PC



圓型電纜接頭



I/O 裝置



媒體 / 協定轉換器



圓型組裝式接頭



安全 (Safety) 裝置

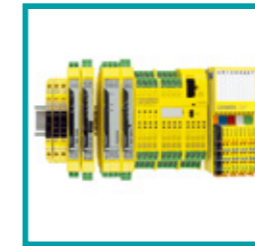

乙太網路交換器



Push-in式面板貫穿接頭



防水型多連接埠



混合式馬達啟動器



接頭端子台



方型接頭



電源分接、中繼用接頭

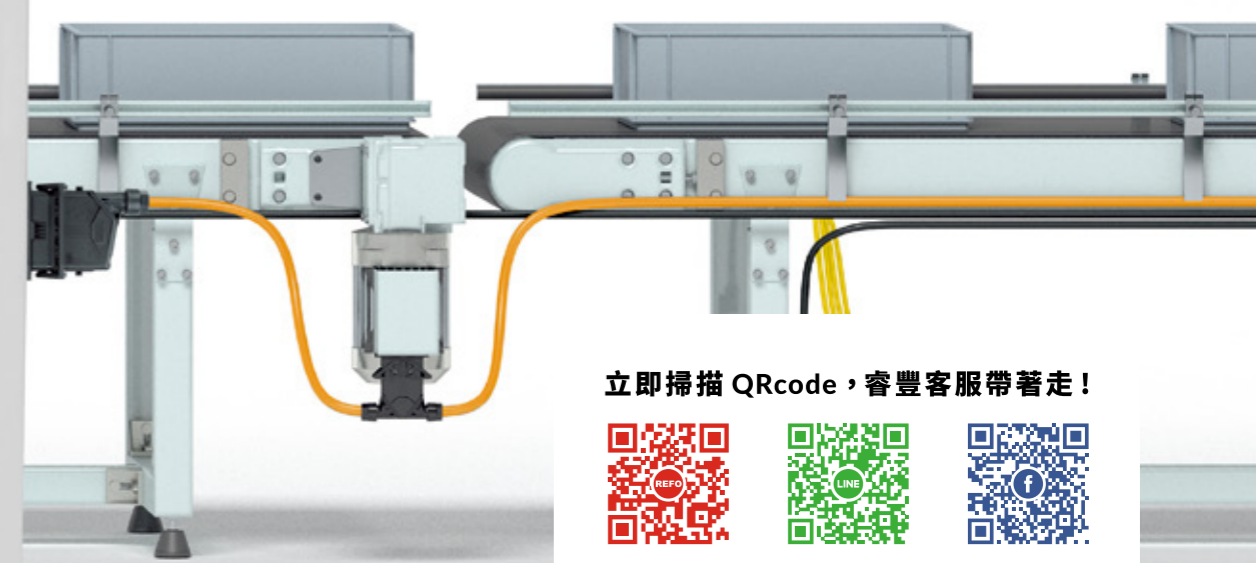

立即掃描 QRcode，睿豐客服帶著走！



馬達驅動應用 革新進化!

■ 精巧設計縮減控制盤尺寸、降低配盤成本

菲尼克斯詢價找睿豐

www.refo-tw.com



採用傳統型電磁接觸器，佔用空間大
配線速度：10 分鐘→ 22 接線點



採用混合式馬達啟動器，尺寸縮減 75%
配線速度：3 分鐘→ 12 接線點

藉由模組寬度 22.5mm 的精巧設計，可更有效運用盤內空間，有助於節省空間。也能彈性因應系統擴充需增加設備等情形。另外，配線也採用 Push-in 式可輕鬆連接，是兼具省工時效果的產品。

寬度縮減
67.5 mm

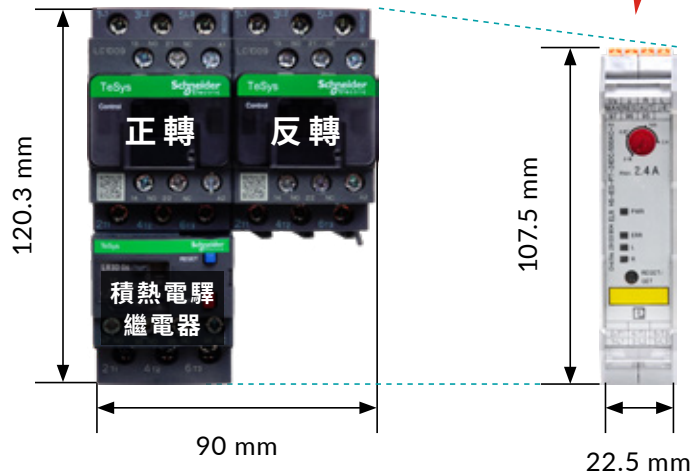

● 傳統型電磁接觸器

一台僅含單一功能，需依用途組合成套，因此占用較多盤內空間。

● 混合式馬達啟動器

一台就含正轉、反轉、積熱電驛、緊急停止等功能，體積大幅縮減。

■ 1台最多4種功能

睿豐工控商城線上下單

www.refo-tw.com

與傳統型馬達啟動器(電磁開關器)比較

- 最多搭載4種功能
 - 正轉用接觸器
 - 反轉用接觸器
 - 積熱電驛
 - 緊急停止用接觸器
- 支援安全應用
 - ISO 13849-1: PLe
 - IEC 61508: SIL 3

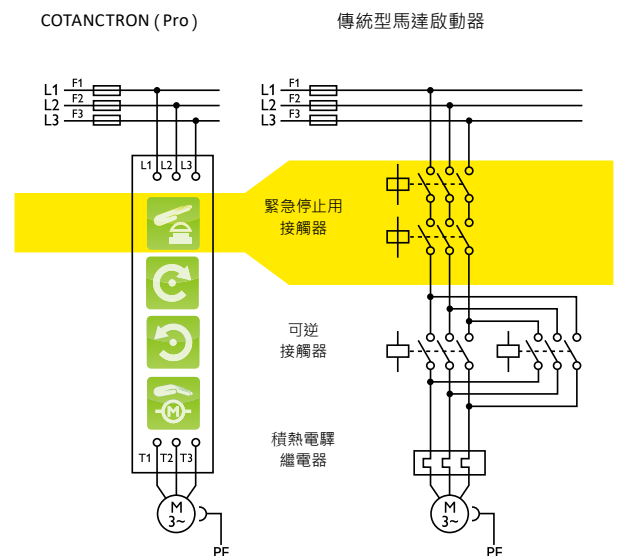

CONTACTRON

最多具備 4 種功能的標準型

縮減盤內空間

· 小型機殼：全部產品 22.5mm 寬

減少替換、維修頻率

· 混合技術才能達到的長壽命

高度預防診斷

· 電子感熱提供各種檢測功能

輕鬆建構安全控制

內建緊急停止接點簡化配線

※取決於機種



Push-in Technology[®]
Designed by PHOENIX CONTACT

CONTACTRON Pro

模組化型 CONTACTRON

減少配線工時

· 採用 DIN 鋁軌匯流排 (T-BUS) 可統一供應電源

額外的監控功能

· 可安裝擴充接點模組

輕鬆建構安全控制

· 可利用專用安全繼電器組件進行群組停止

※取決於機種



Push-in Technology[®]
Designed by PHOENIX CONTACT

CONTACTRON Hybrid Technology[®]

Designed by PHOENIX CONTACT

混合技術是透過微處理器發揮出『固態繼電器』與『機械式接點』優點的獨家技術。

- 固態繼電器
只在啟動、停止時的瞬間使用 ⇒ SSR 溫度不會上升 · 不需要散熱片
- 機械式接點
在接點劣化較嚴重的啟動、停止時以外使用 ⇔ 啟動時沒有負擔 · 縮小接點與線圈體積

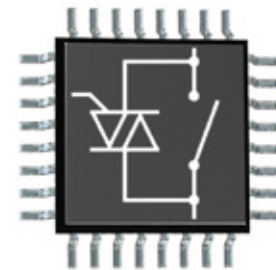

■ 模組化型的特色



- 統一供應電源
簡化控制電源的配線

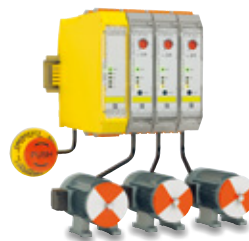

- 安全群組停止
簡化安全控制的配線







- 與擴充接點組件連結
擴充監控馬達狀態

REFO 睿豐特選推薦款

型	CONTACTRON 系列 · 可逆		CONTACTRON 系列 · 正轉	
外觀				
額定電流值	2.4A	9A	2.4A	9A
型號	ELR H5-I-PT- 24DC/500AC-2 2903910	ELR H5-I-PT- 24DC/500AC-9 2903912	ELR H3-I-PT- 24DC/500AC-2 2903922	ELR H3-I-PT- 24DC/500AC-9 2903924

所有款式一覽

型	CONTACTRON			CONTACTRON Pro		
外觀						
額定電流值	0.6A	2.4A	9A	3A	9A	
功能	可逆+緊急停止 (附下限檢測)	ELR H5-IES-PT- 24DC/500AC-0,6 2903902	ELR H5-IES-PT- 24DC/500AC-2 2903904	ELR H5-IES-PT- 24DC/500AC-9 2903906	ELR H5-IES-PT- 24DC/500AC-3-P 2909556	ELR H5-IES-PT- 24DC/500AC-9-P 2909554
	正轉+緊急停止 (附下限檢測)	ELR H3-IES-PT- 24DC/500AC-0,6 2903914	ELR H3-IES-PT- 24DC/500AC-2 2903916	ELR H3-IES-PT- 24DC/500AC-9 2903918	ELR H3-IES-PT- 24DC/500AC-3-P 2909557	ELR H3-IES-PT- 24DC/500AC-9-P 2909555
	可逆+緊急停止	-	-	-	ELR H5-IS-PT- 24DC/500AC-3-P 2909569	ELR H5-IS-PT- 24DC/500AC-9-P 2909567
	正轉+緊急停止	-	-	-	ELR H3-IS-PT- 24DC/500AC-3-P 2909570	ELR H3-IS-PT- 24DC/500AC-9-P 2909568
	可逆	ELR H5-I-PT- 24DC/500AC-0,6 2903908	ELR H5-I-PT- 24DC/500AC-2 2903910	ELR H5-I-PT- 24DC/500AC-9 2903912	ELR H5-I-PT- 24DC/500AC-3-P 2909562	ELR H5-I-PT- 24DC/500AC-9-P 2909560
	正轉	ELR H3-I-PT- 24DC/500AC-0,6 2903920	ELR H3-I-PT- 24DC/500AC-2 2903922	ELR H3-I-PT- 24DC/500AC-9 2903924	ELR H3-I-PT- 24DC/500AC-3-P 2909563	ELR H3-I-PT- 24DC/500AC-9-P 2909561
控制電路	電源	額定輸入電壓 DC24V			DC24V	
		輸入電壓範圍 DC19.2 ~ 30V			DC19.2 ~ 30V	
		消耗電流 40mA			60mA	
	信號	額定輸入電壓 DC24V			DC24V	
	輸入電壓範圍 DC19.2 ~ 30V			DC19.2 ~ 30V		
	消耗電流 5mA			7mA		
主電路	突波保護	有			有	
	開關電壓範圍	三相 AC42 ~ 550V (50/60Hz)			三相 AC42 ~ 550V (50/60Hz)	
	漏電流	0mA			0mA	
	突波電壓	6kV			6kV	
	突波保護	有			有	
	積熱設定範圍	0.075 ~ 0.6A	0.18 ~ 2.4A	1.5 ~ 9A	3A (AC51 · AC53a)	9A (AC51) · 7A (AC53a)
顯示	跳脫級別 (IEC 60947-4-2)	Class 10A			Class 10	Class 10A
	接點構成 / 材質	1c 接點			1c 接點	
	最大接點電流	3A/AC230V (AC15) · 2A/DC24V (DC13)			2A/DC24V (DC13)	
	電源電壓	錯誤 Err (紅)			PWR (綠)	
其他	錯誤	L / R / ON (黃)			L / R / ON (黃)	
	電氣壽命	3x10 ⁷ 次			3x10 ⁷ 次	
	使用環境溫度	-25 ~ 70°C			-25 ~ 70°C	
	保存溫度	-40 ~ 80°C			-40 ~ 80°C	
規格、認證	尺寸 (W×H×D)	22.5×99×114.5mm			22.5×99×114.5mm	
	認證	UL Listed			UL Listed	
	安全規格	IEC 61508: SIL 3 ⁽¹⁾			IEC 61508: ≤ SIL 3	
防塵規格	ISO 13849: ≤ Category 3 · ≤ Ple ⁽²⁾			ISO 13849: ≤ Category 3 · ≤ Ple		
防爆規格	ATEX ⁽³⁾			ATEX		

■ CONTACTRON / CONTACTRO Pro通用配件

配件	種類	型號	產品編號
 三相電源用短路條	2 個短路條用	BRIDGE-PT 2	2904490
	3 個短路條用	BRIDGE-PT 3	2904491
	4 個短路條用	BRIDGE-PT 4	2904492
	5 個短路條用	BRIDGE-PT 5	2904493
	6 個短路條用	BRIDGE-PT 6	2904494
	7 個短路條用	BRIDGE-PT 7	2904495
	8 個短路條用	BRIDGE-PT 8	2904496
	9 個短路條用	BRIDGE-PT 9	2904497
	10 個短路條用	BRIDGE-PT 10	2904498
	護蓋	BRIDGE COVER	2906240



■ CONTACTRON Pro用配件

配件	種類	型號	產品編號
 主體用 T-BUS 接頭	T-BUS 接頭	ELR-TBUS-22,5-P	2203861
 擴充接點組件 ※ 隨附 1 個 T-BUS 接頭	主體	EM-2RPT/21AU-R/L-P	2909573
	T-BUS 接頭	ELR-TBUS-22,5-P	2203861
 安全繼電器組件	主體	PSR-MC38-2NO-1DO-24DC-PI	1009832
	T-BUS 接頭	PSR-TBUS	2890425
 電源組件	主體	MINI-SYS-PS-100-240AC/24DC/1.5	2866983
	T-BUS 接頭	ME 17,5 TBUS 1,5/ 5-ST-3,81GN	2709561

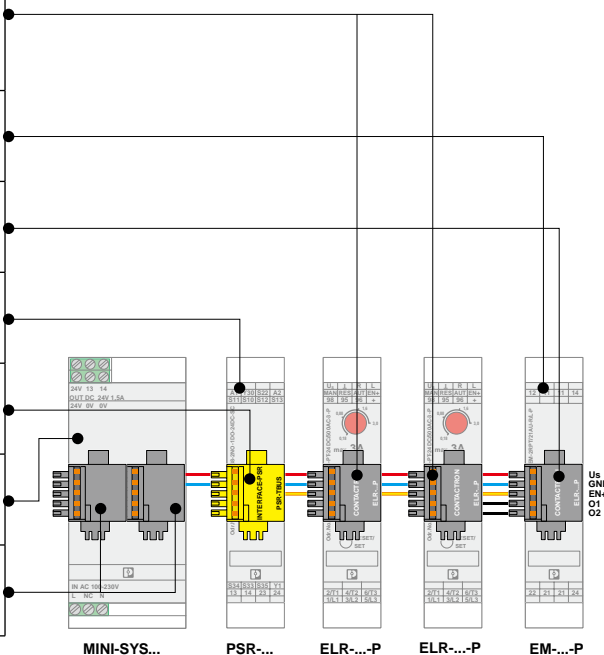

bore 柏觀自動化科技股份有限公司

ADD: 408009 台中市南屯區永春東路 690 號

TEL: +886-4-2380-9449

FAX: +886-4-2380-6309

E-mail: info@bore.com.tw

www.bore.com.tw



柏觀省配線模組

柏觀自動化



柏觀 LINE ID

0978963395



柏觀 Facebook 粉絲團

柏觀自動化



柏觀 GOOGLE

柏觀自動化

REFO 睿豐自動化股份有限公司

ADD: 408009 台中市南屯區永春東路 690 號

TEL: +886-4-2380-3220

FAX: +886-4-2380-6309

E-mail: info@refo-tw.com

www.refo-tw.com



睿豐工控商城

睿豐自動化



睿豐 LINE ID

0978283633



睿豐 Facebook 粉絲團

REFO Automation

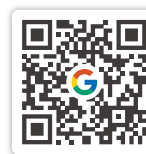

睿豐 GOOGLE

睿豐自動化

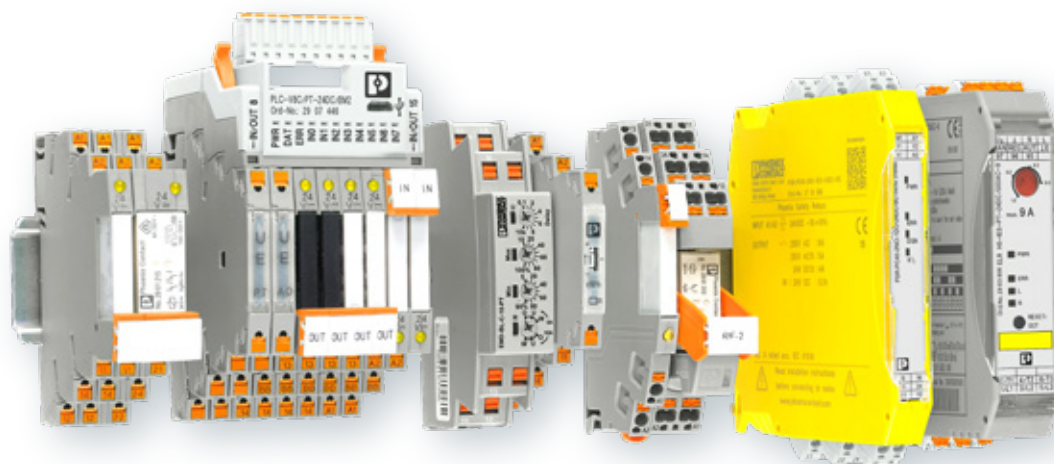

bore **REFO**

提供您更完整的技術服務

REFO 睿豐自動化股份有限公司

ADD : 408009 台中市南屯區永春東路690號
TEL : +886-4-2380-3220
FAX : +886-4-2380-6309
E-mail : info@refo-tw.com

www.refo-tw.com

WEBSITE



LINE



FACEBOOK



GOOGLE



bore 柏叡自動化科技股份有限公司

ADD : 408009 台中市南屯區永春東路690號
TEL : +886-4-2380-9449
FAX : +886-4-2380-6309
E-mail : info@bore.com.tw

www.bore.com.tw

WEBSITE



LINE



FACEBOOK



GOOGLE

